

# Instrucțiuni de asamblare pentru peretele de duș

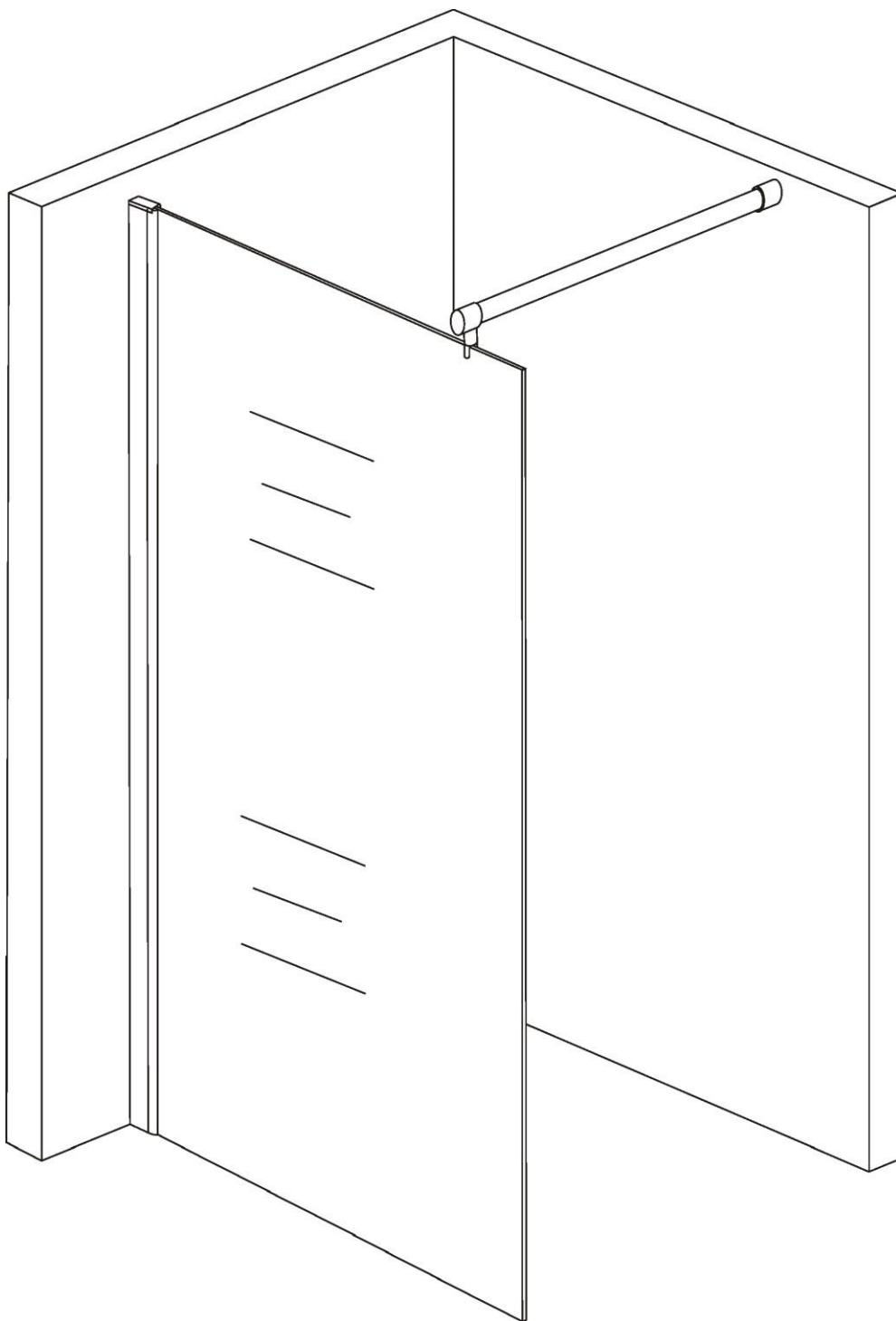

## Unelte necesare

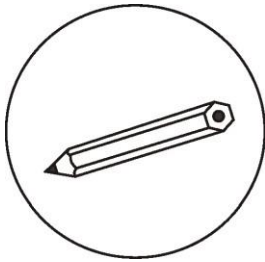

Creion

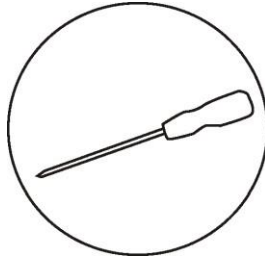

Șurubelniță(cruce)



Burghiu

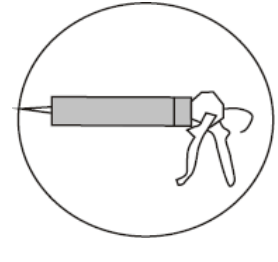

Gel de silicon

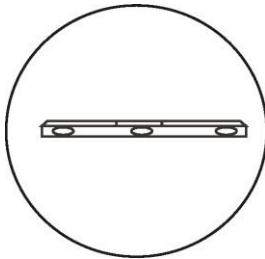

Nivel de spirit

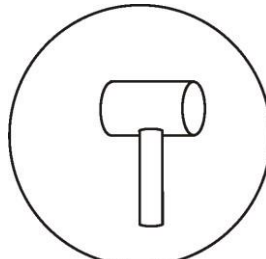

Ciocan de cauciuc

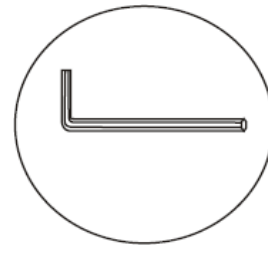

Cheie Allen

## Lista de piese

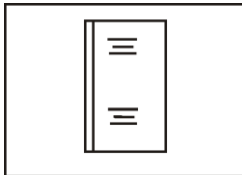

Perete de sticlă

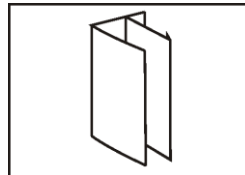

Perete profil U

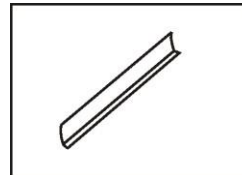

Capacul profilului



P-J4515

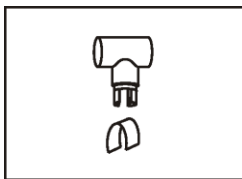

PJ-4416

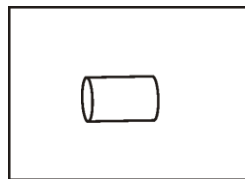

PJ-4405

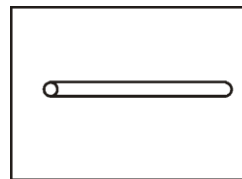

LG-2004

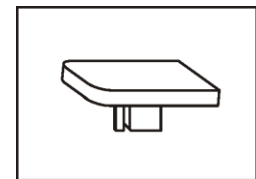

PJ-4506

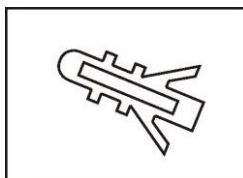

Priză de perete

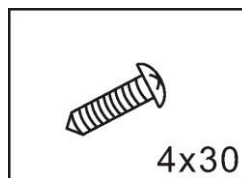

Șurub de perete  
4x30

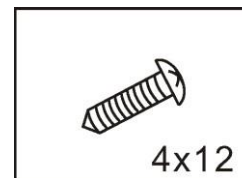

Șurub profilat  
4x12

1. Setați profilul de perete pe verticală, folosiți un nivel cu bulă de aer pentru a vă ajuta.
2. Marcați găurile de găurire
3. Se găurește la marcaj și se plasează diblurile în perete.
4. Înșurubați profilul pe perete

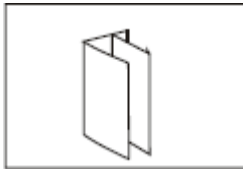

**Profil de perete**



**Șurub de perete**

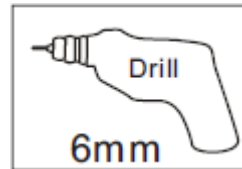

**Mașină de găurit**



**Priză de perete**

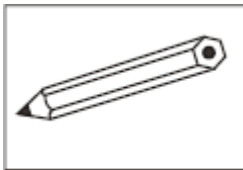

**Creion**

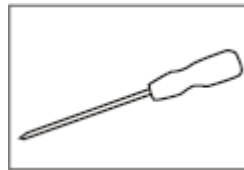

**Șurubelniță(cruce)**

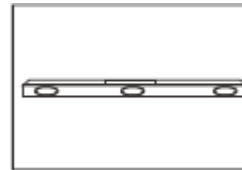

**Nivel de spirit**

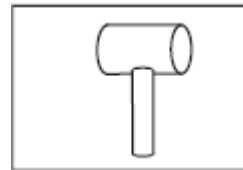

**Ciocan de cauciuc**

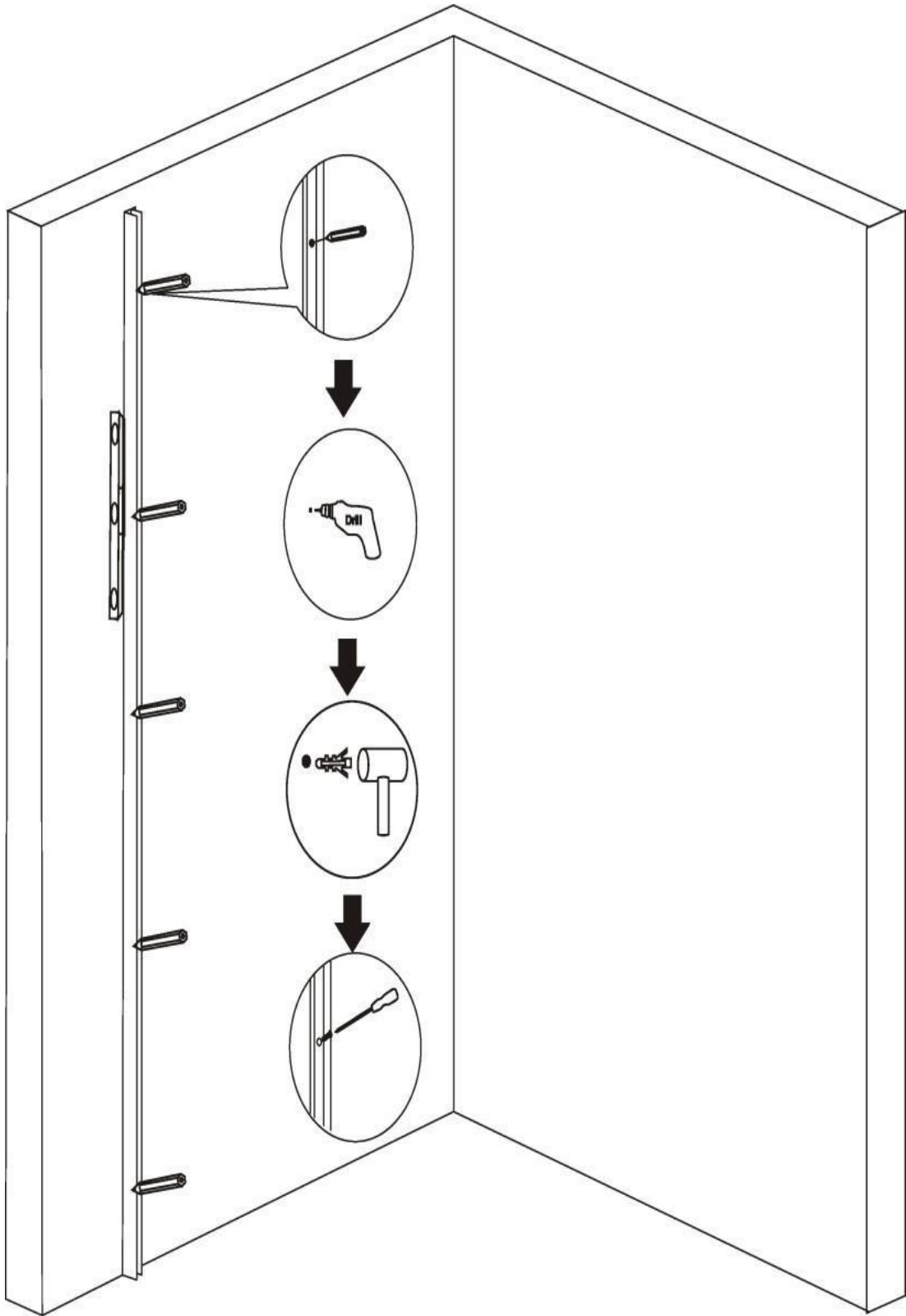

Ghidați cu grijă paravanul de duș în profilul de perete (lăsați protecția marginilor pe sticlă).

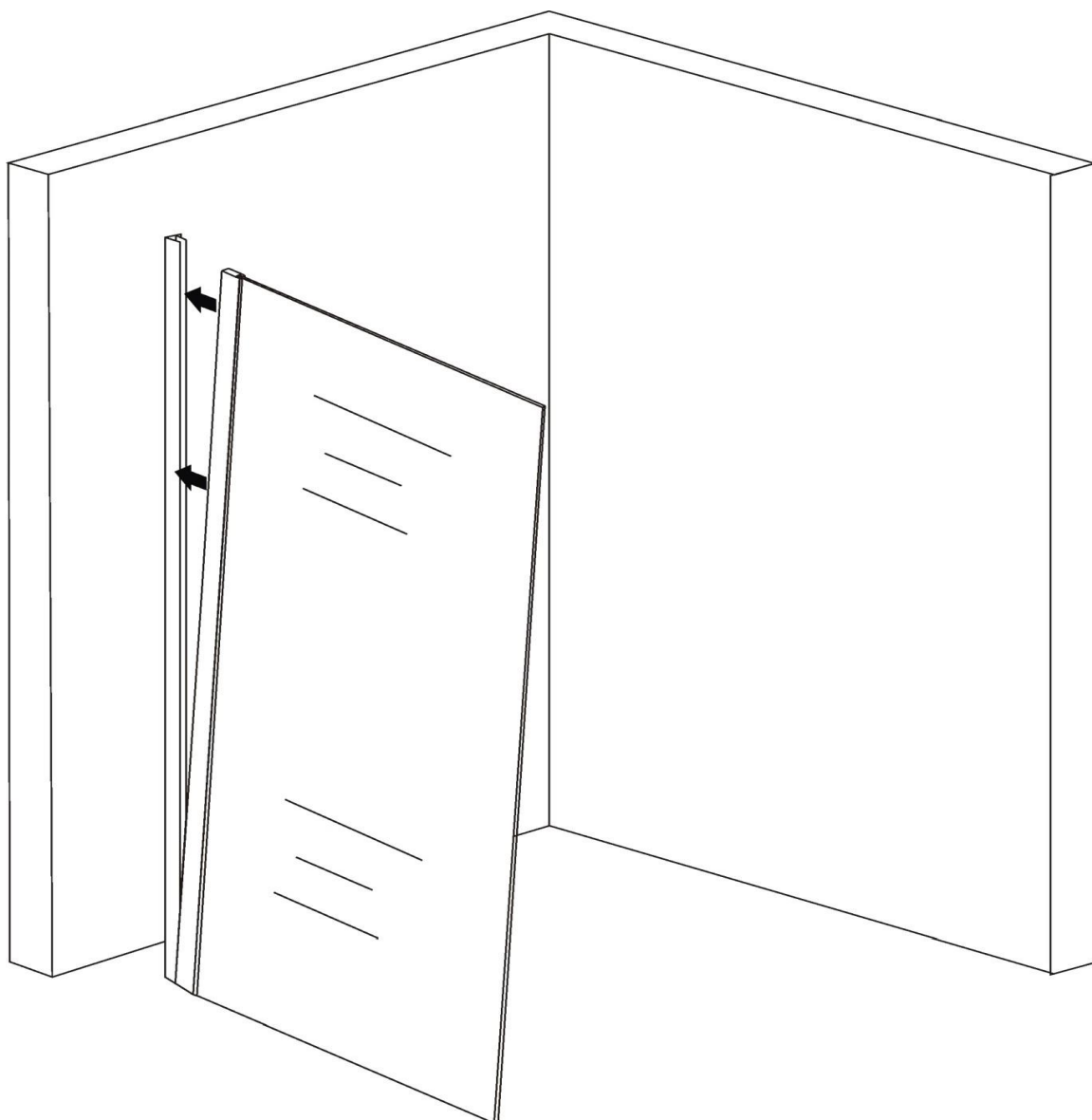
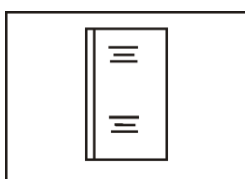

1. Perforați prin profilul de perete în punctele desemnate și fixați peretele de duș cu ajutorul șuruburilor furnizate.
2. Apoi montați banda de acoperire pentru a ascunde conexiunea cu șuruburi; aceasta trebuie să fie fixată în poziție.

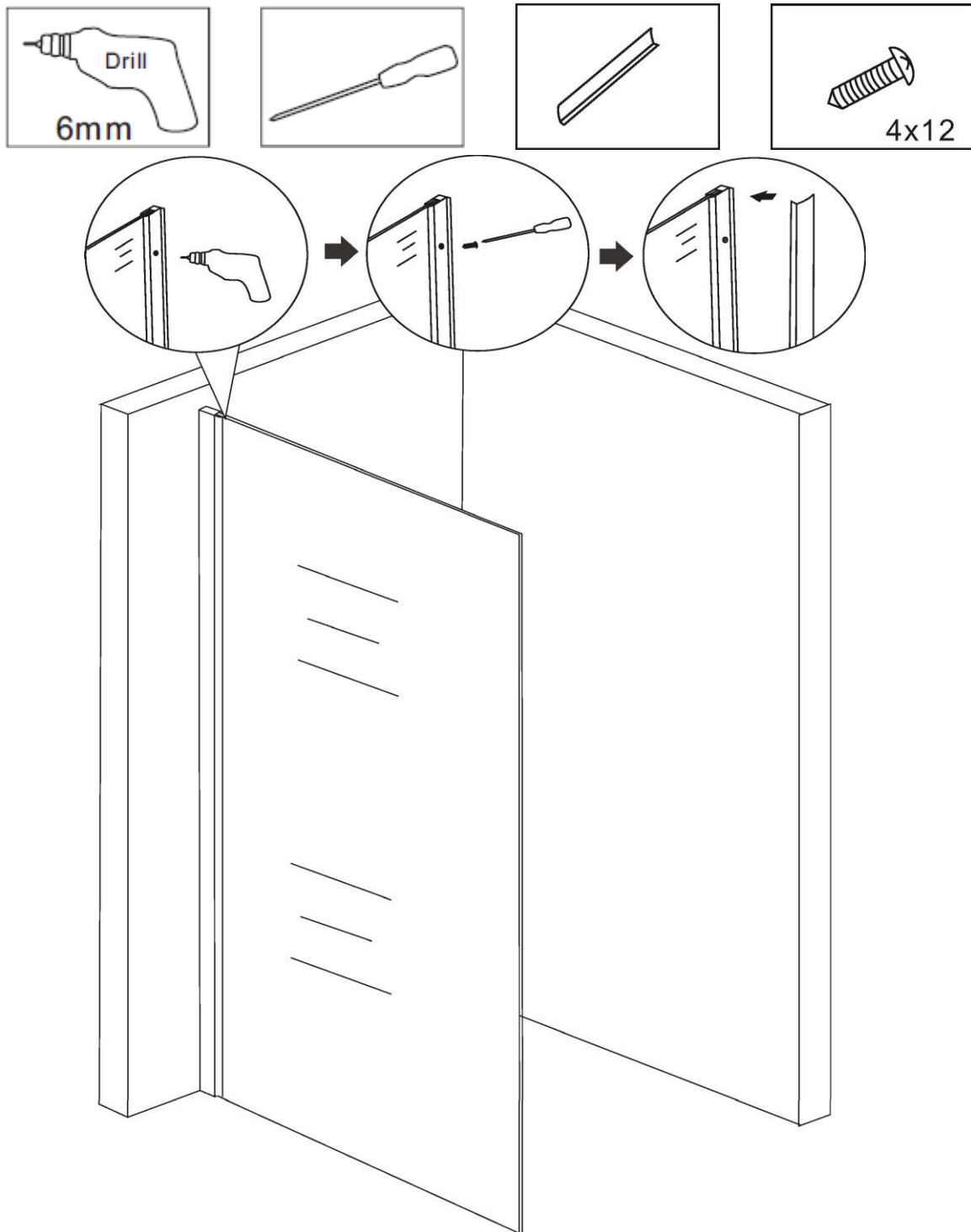

Ataşați capacul profilului superior și etanșați peretele de duș din interior și exterior cu ajutorul siliconului.

