

Instrucțiuni de montaj

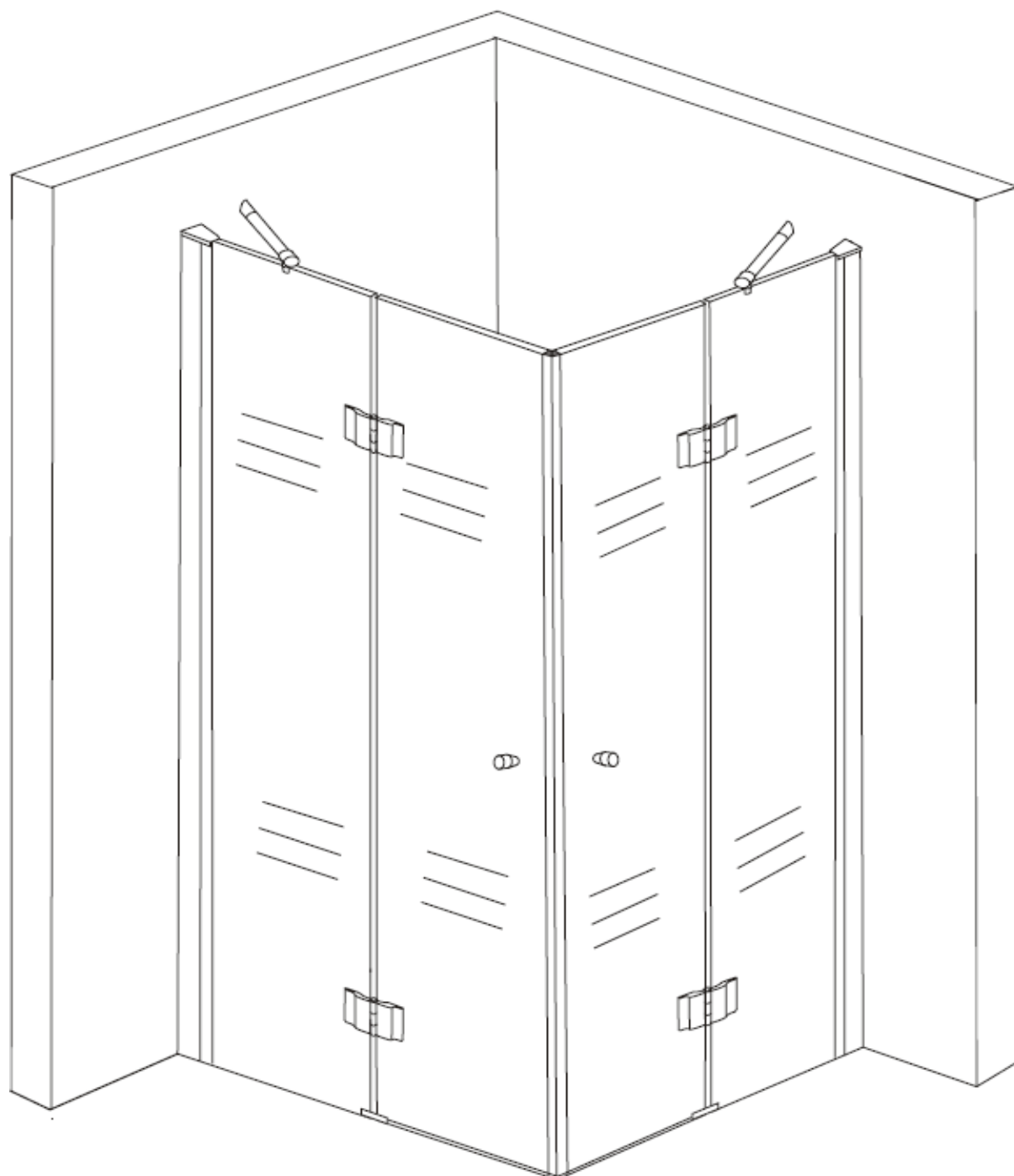

RoHS **CE** **ISO9001:2000**

Instrument necesar

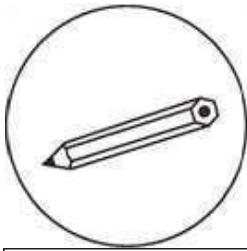

Creion

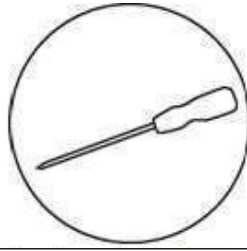

surubelnita



bormasina

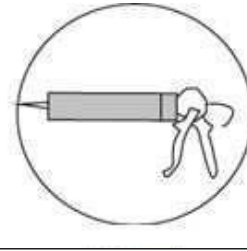

silicon

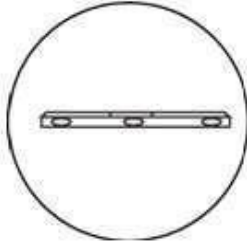

boloboc

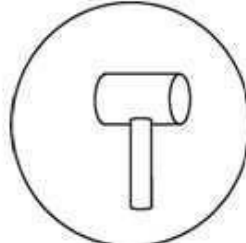

ciocan de cauciuc

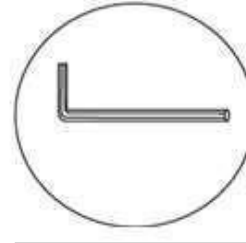

cheie hexagonala

Părți

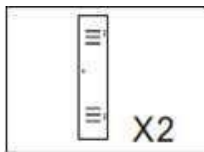

Glas Tile
sticla

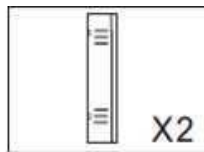

Wood Glas
sticla

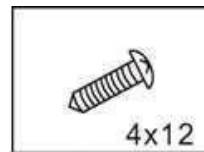

4x12
Profil Schraub
surub

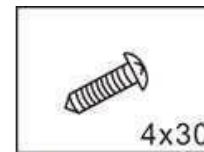

4x30
surub



CT-8DSTW180



CT-8BMX90



PJ-4579

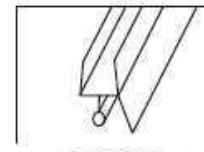

CT-8DSTQ

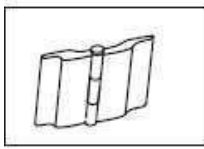

HY-3304

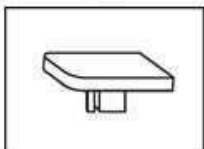

PJ-4509

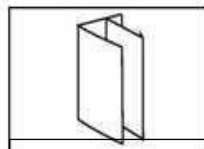

profil

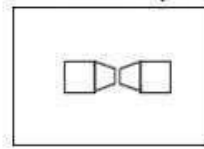

LS-1201

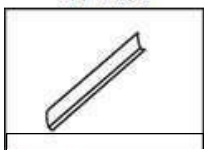

profil



Wand
diblu

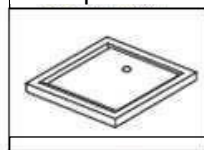

cadita



PJ-4317



LG-2004

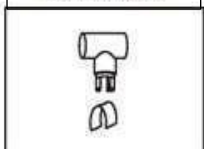

PJ-4416

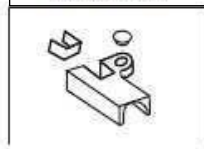

PJ-4527/4526(2X)

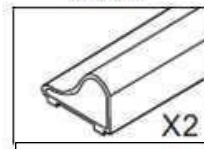

Profil

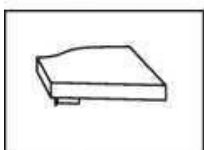

PJ-4514/4515

Marcați liniile ca si in tabel

Măsurători	Profilul peretelui	L1	L2
1000 x 800	Pre-foraj	970	770
1000 x 900	Pre-foraj	970	870
1000 x 1000	Pre-foraj	970	970
1200 x 900	Pre-foraj	1170	870
1200 x 1000	Pre-foraj	1170	970
1200 x 1200	Pre-foraj	1170	1170

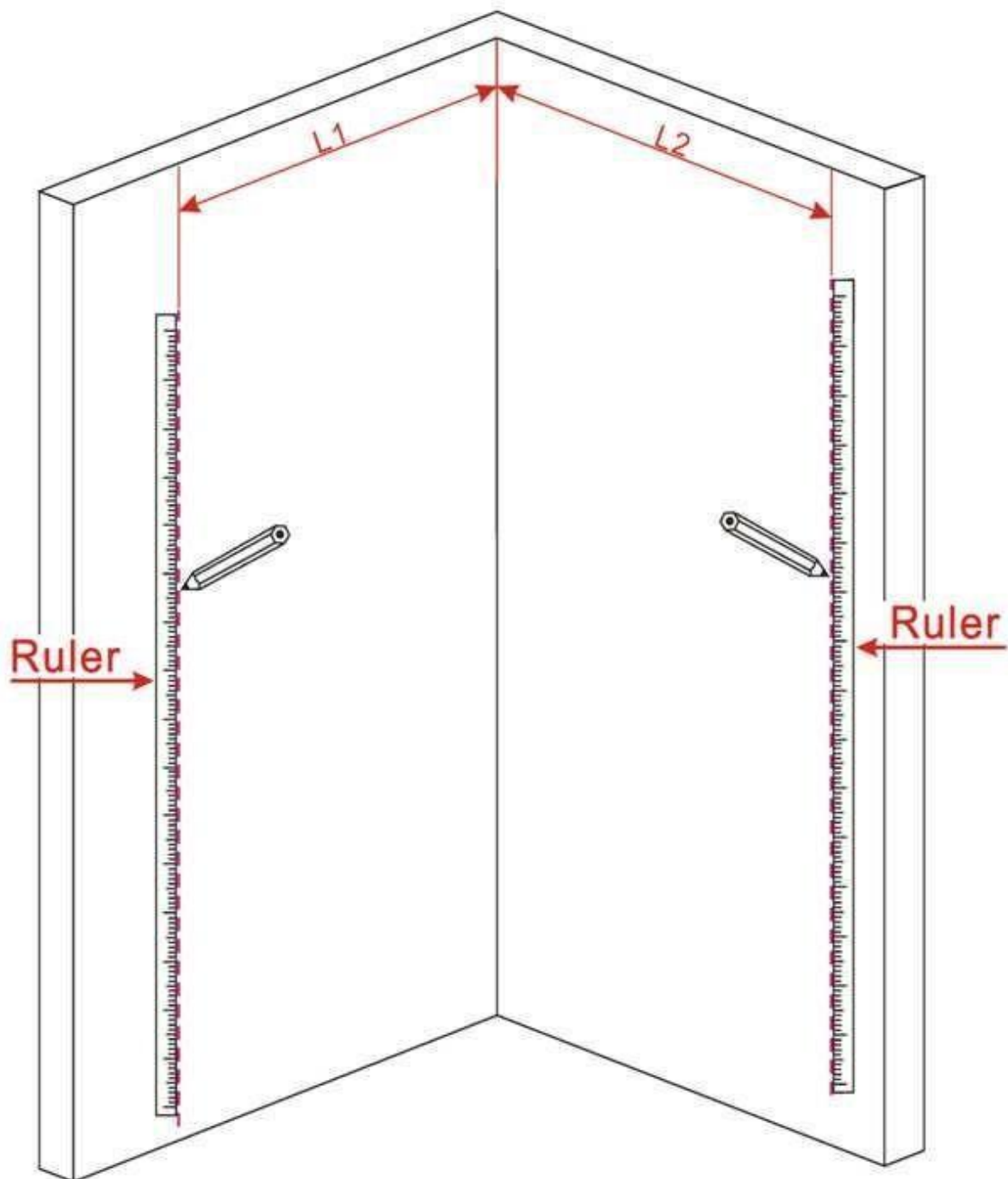

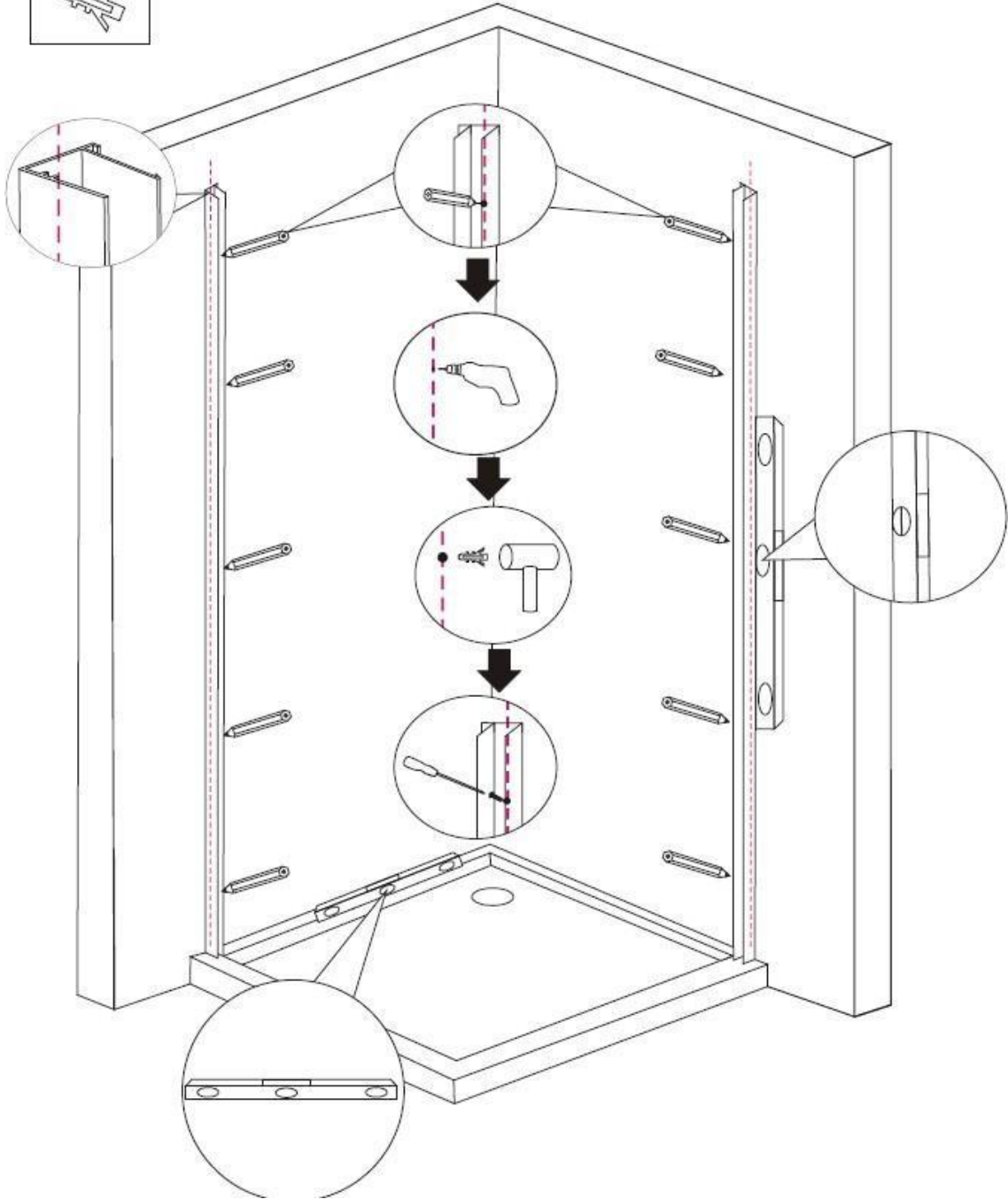
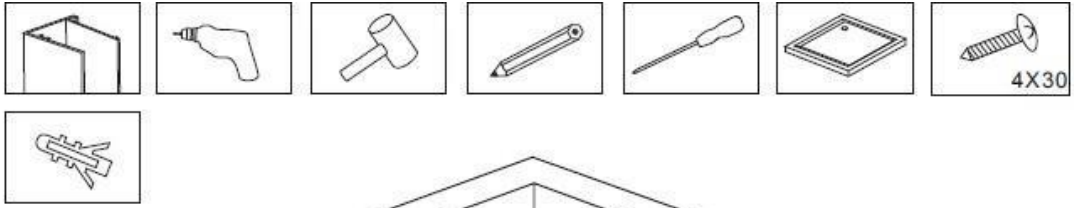

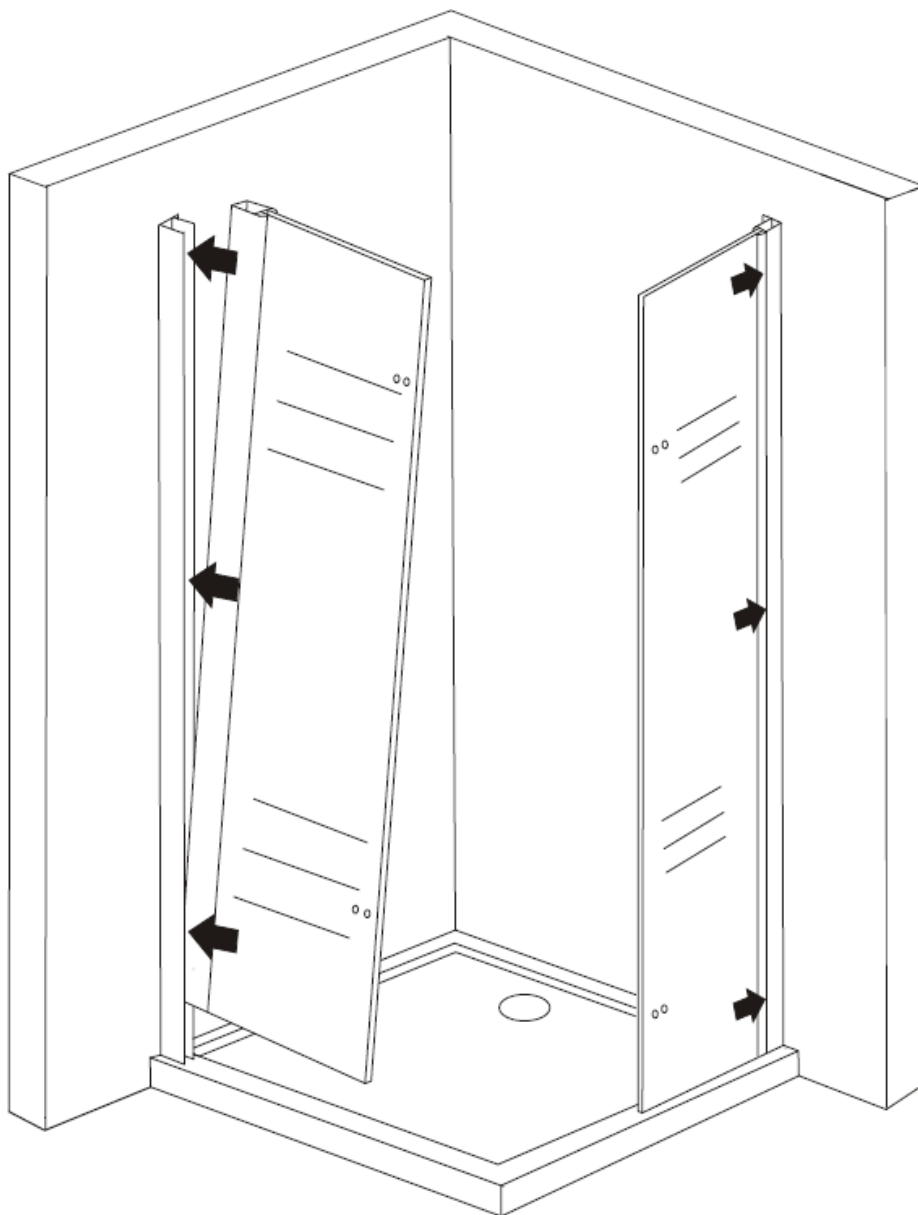
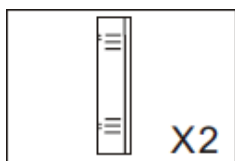

Vă rugăm să acordați întotdeauna atenție unei baze moi atunci când configurați . lăsați protecția de margine pe sticlă



