

## Instrucțiuni de montaj

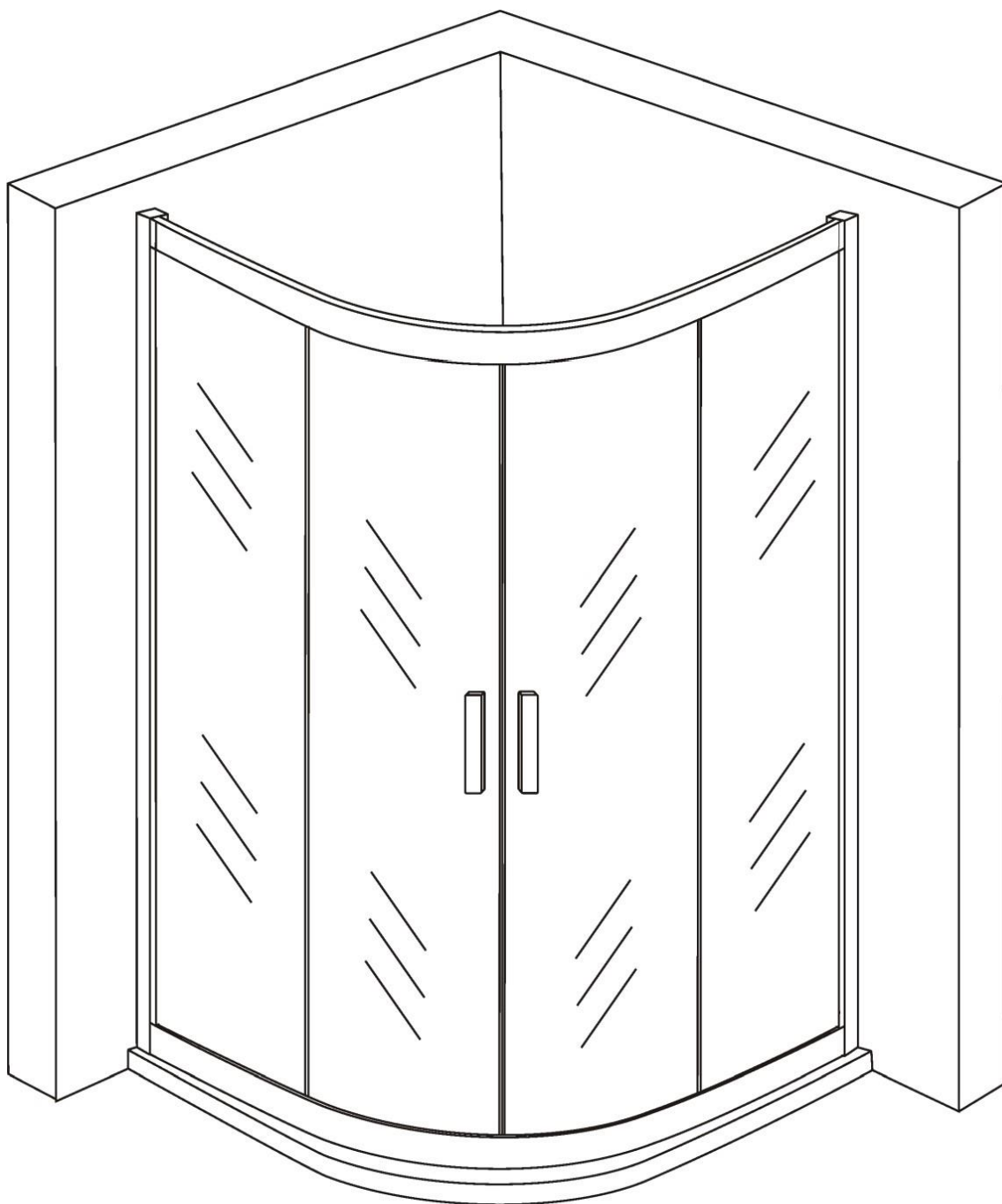

3056/3055

**RoHS** **CE** **ISO9001:2000**

## Instrument necesar

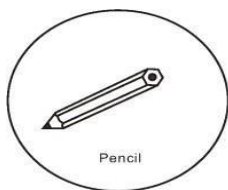

Pencil

Creion

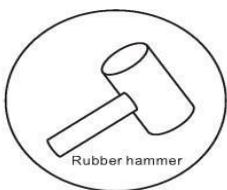

Rubber hammer

Ciocan de cauciuc



Driller

Bormasina

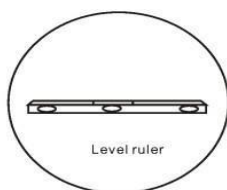

Level ruler

Boloboc

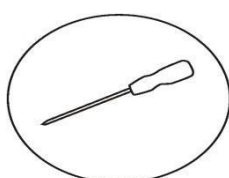

Șurubelniță

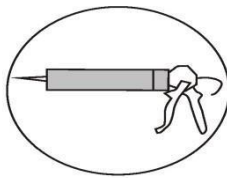

silicon

## Părți

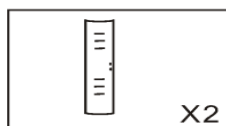

X2

Usa de sticla

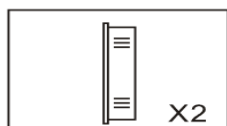

X2

sticla de perete

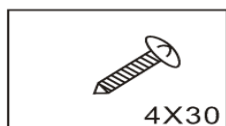

4X30

șurub

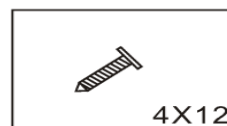

4X12

surub

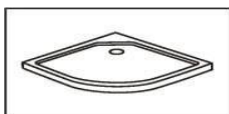

Tavă de duș

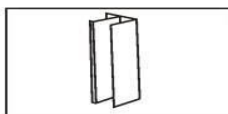

Bandă de acoperire

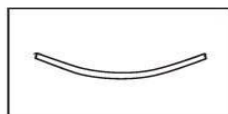

suport

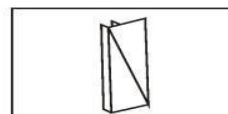

profil de perete

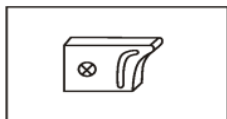

PJ-4626



Bandă magnetică

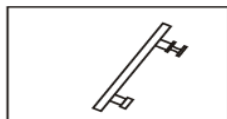

mânerul ușii



bandă de etanșare

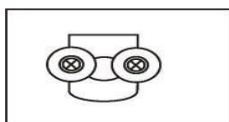

Role (sus)

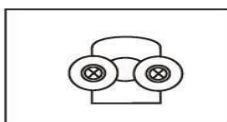

Role (jos)

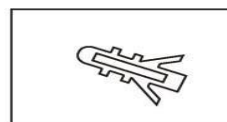

dibluri

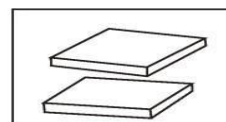

Capac profi

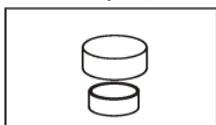

PY-4645 PJ-4502/4503

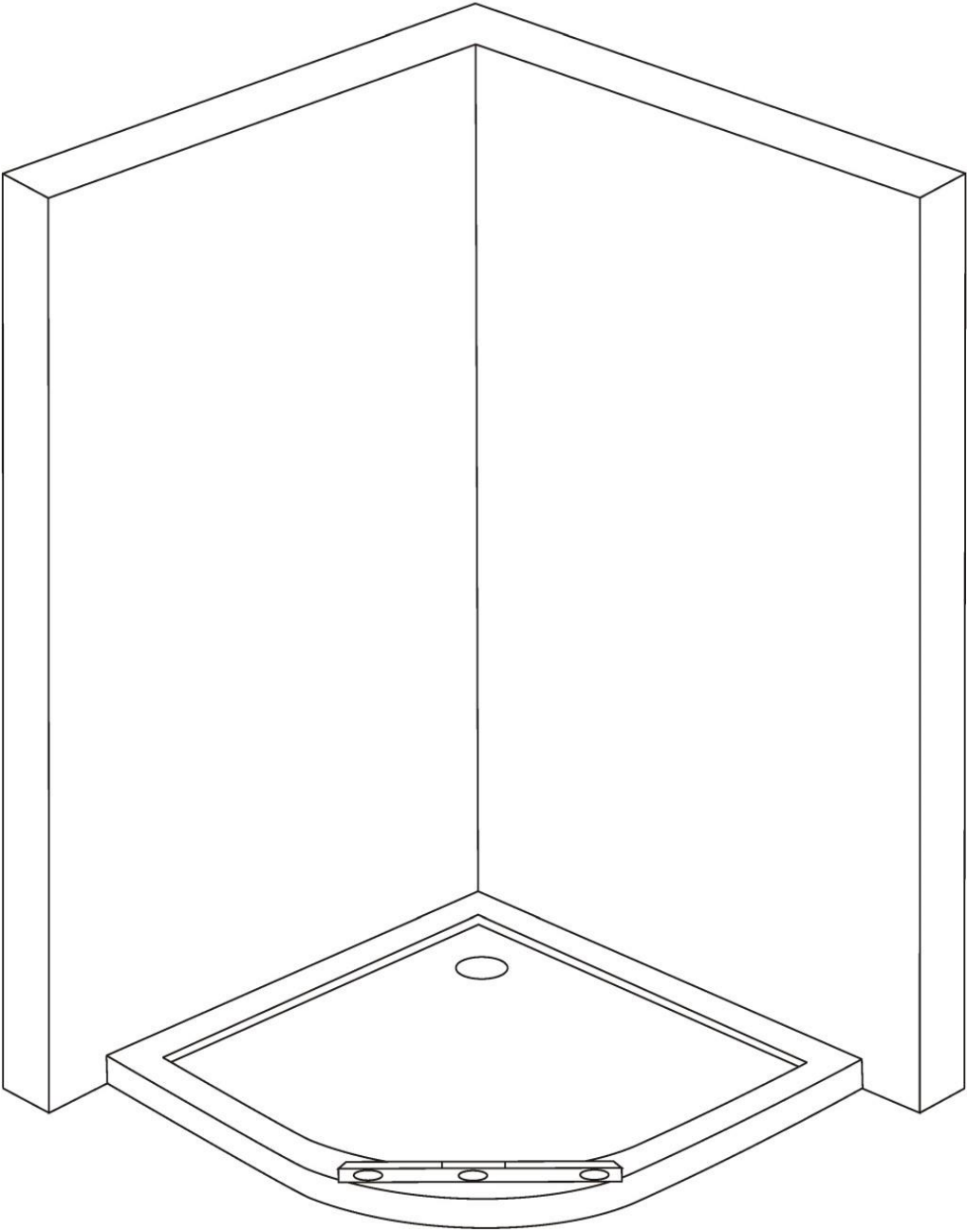
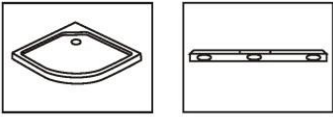

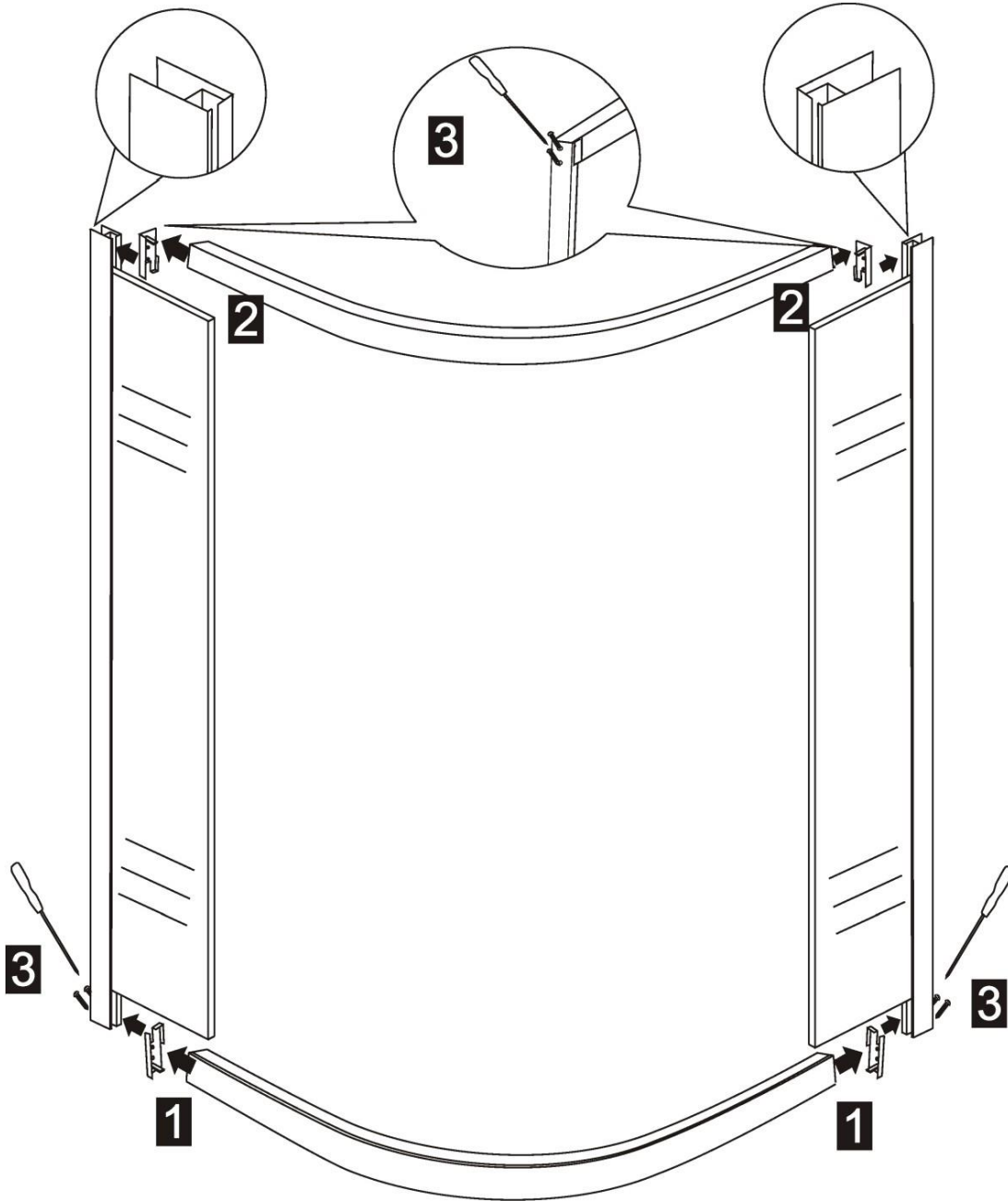
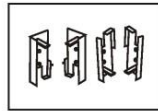
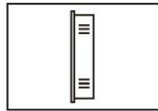
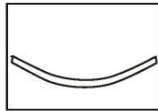
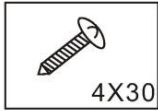
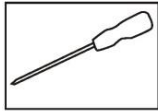

Desenați linia de montare pentru profilurile de perete ca si in tabel

Dimensiuni cabină de duș	1 (L1)	2 (L2)
80 x 80 cm	760 mm	760 mm
90 x 90 cm	860 mm	860 mm

