

Instrucțiuni de montaj

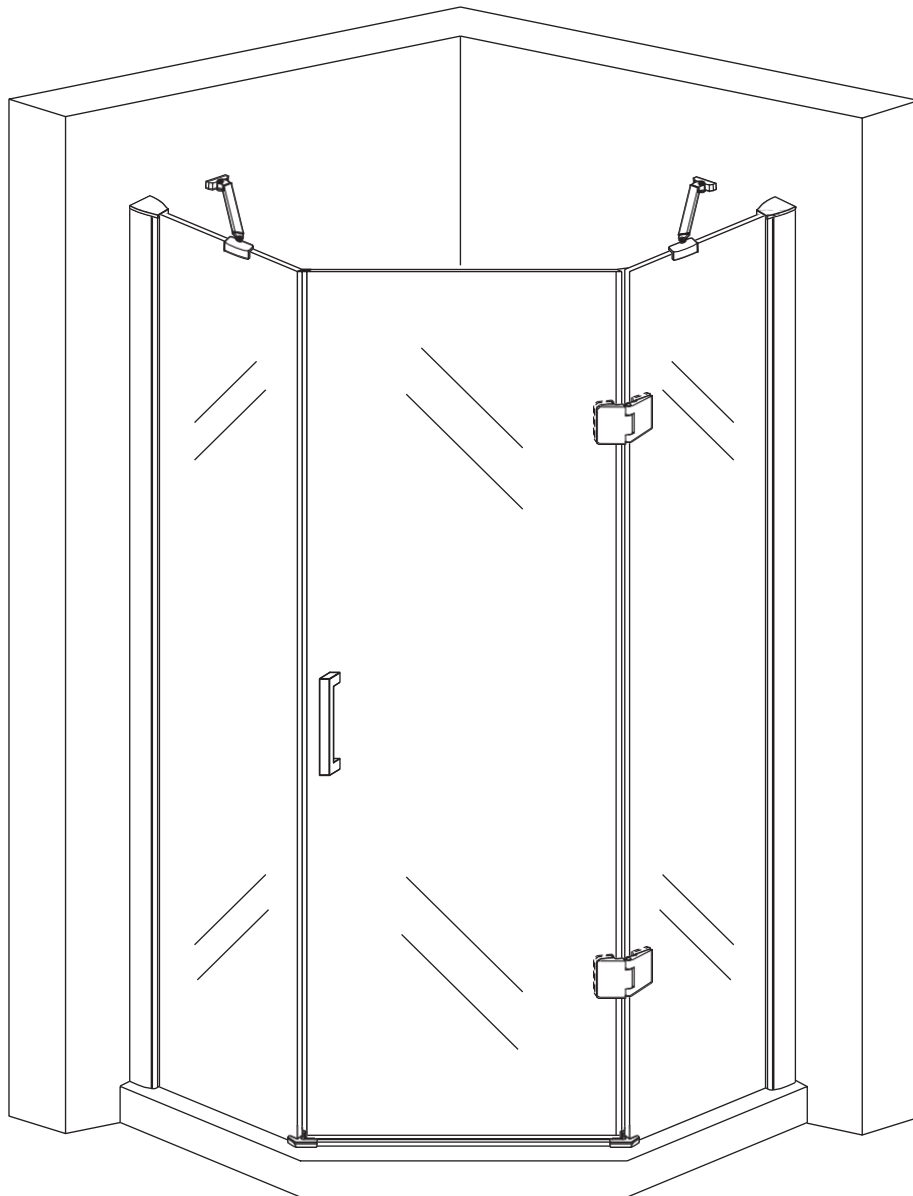

3046/3047

RoHS  ISO9001:2008

Instrument necesar

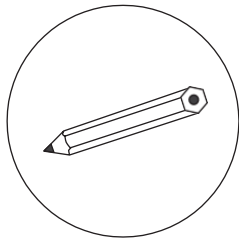

Creion

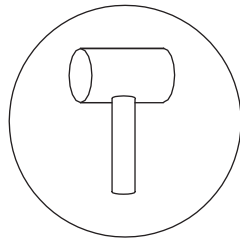

Ciocan de cauciuc

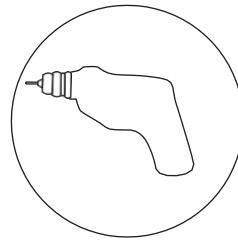

Bormasina

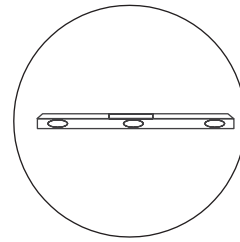

Boloboc

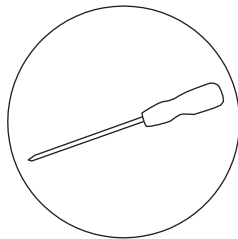

Șurubelniță

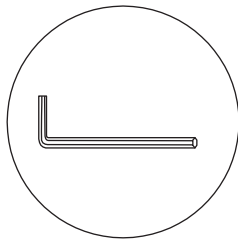

cheie hexagonală

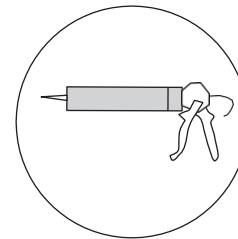

Silicon

Părți

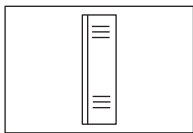

Glass

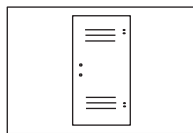

Glass

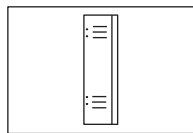

Glass



Screw
4x16



Screw
4x30

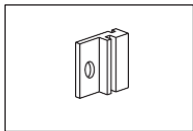
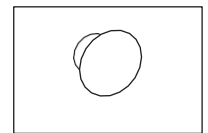

PY-4690

Tray

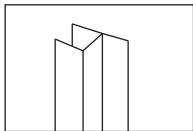

CT-8DST180

CT-8DSTQ

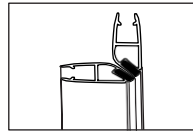

CT-8BMX90

PJ-4509

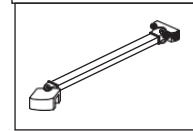

LG-2008

Side cover

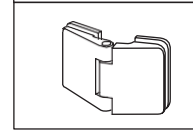

HY-3321

Wall profile

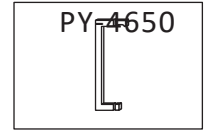

PY-4650

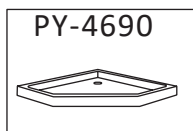

PY-4690

Tray

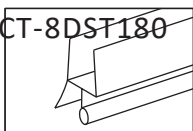

CT-8DST180

CT-8DSTQ

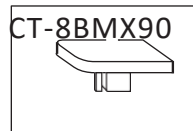

CT-8BMX90

PJ-4509

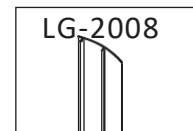

LG-2008

Side cover

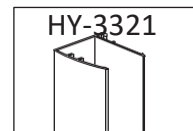

HY-3321

Wall profile

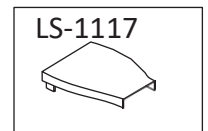

LS-1117

PJ-4514/
PJ-4515

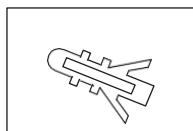

Expand tube

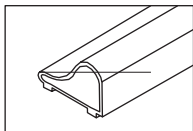

Aluminum
bottom bar

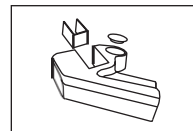

PJ-4524/
PJ-4525

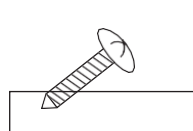

Screw

4x12

Dübel sind nicht für alle Mauerwerke geeignet

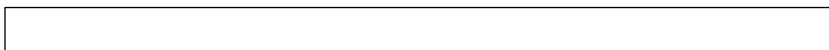

Asamblare in functie de dimensiunea cabinei de dus

Măsurători	L1	L2
900X900mm	875mm	875mm
1000X1000mm	975mm	975mm

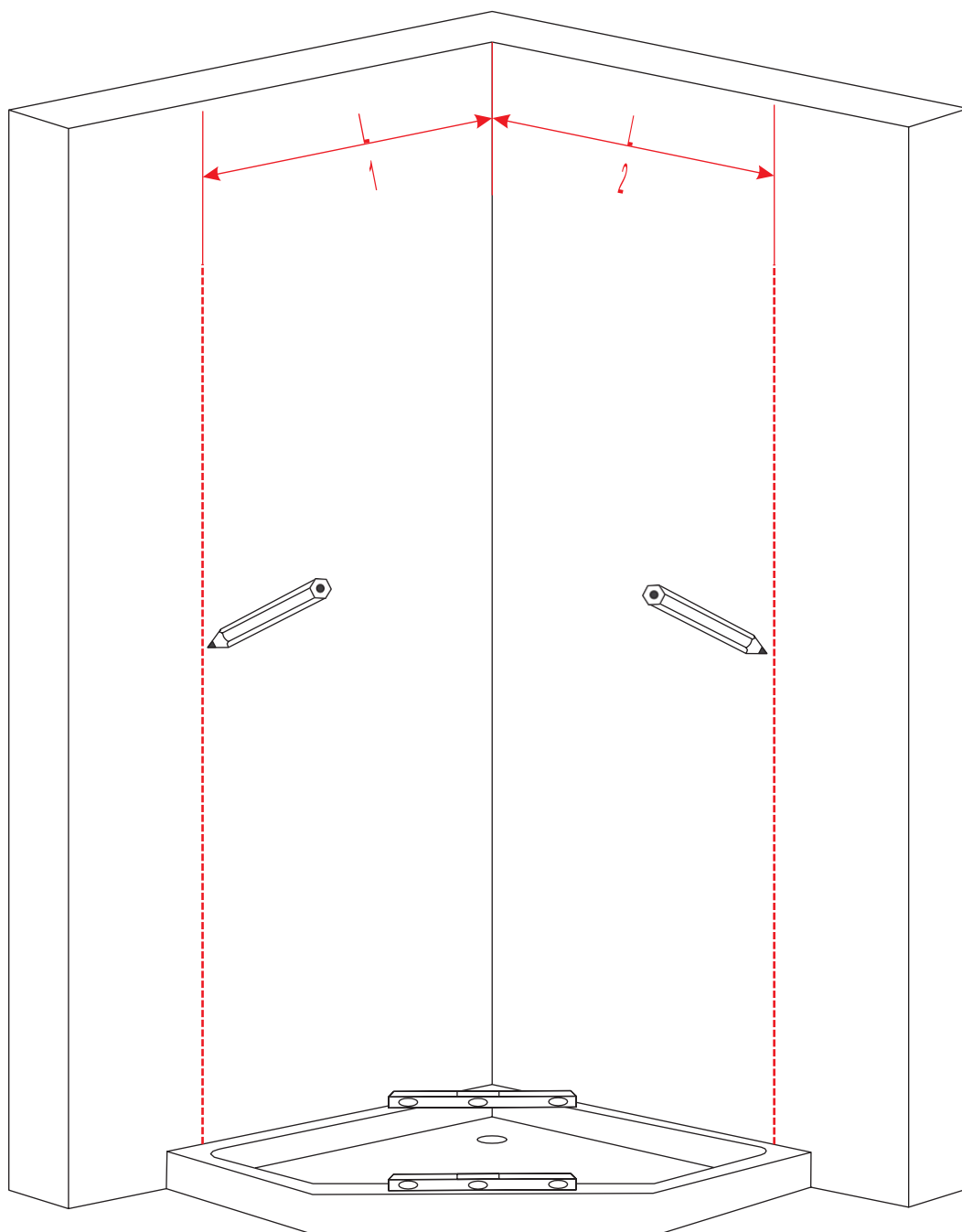

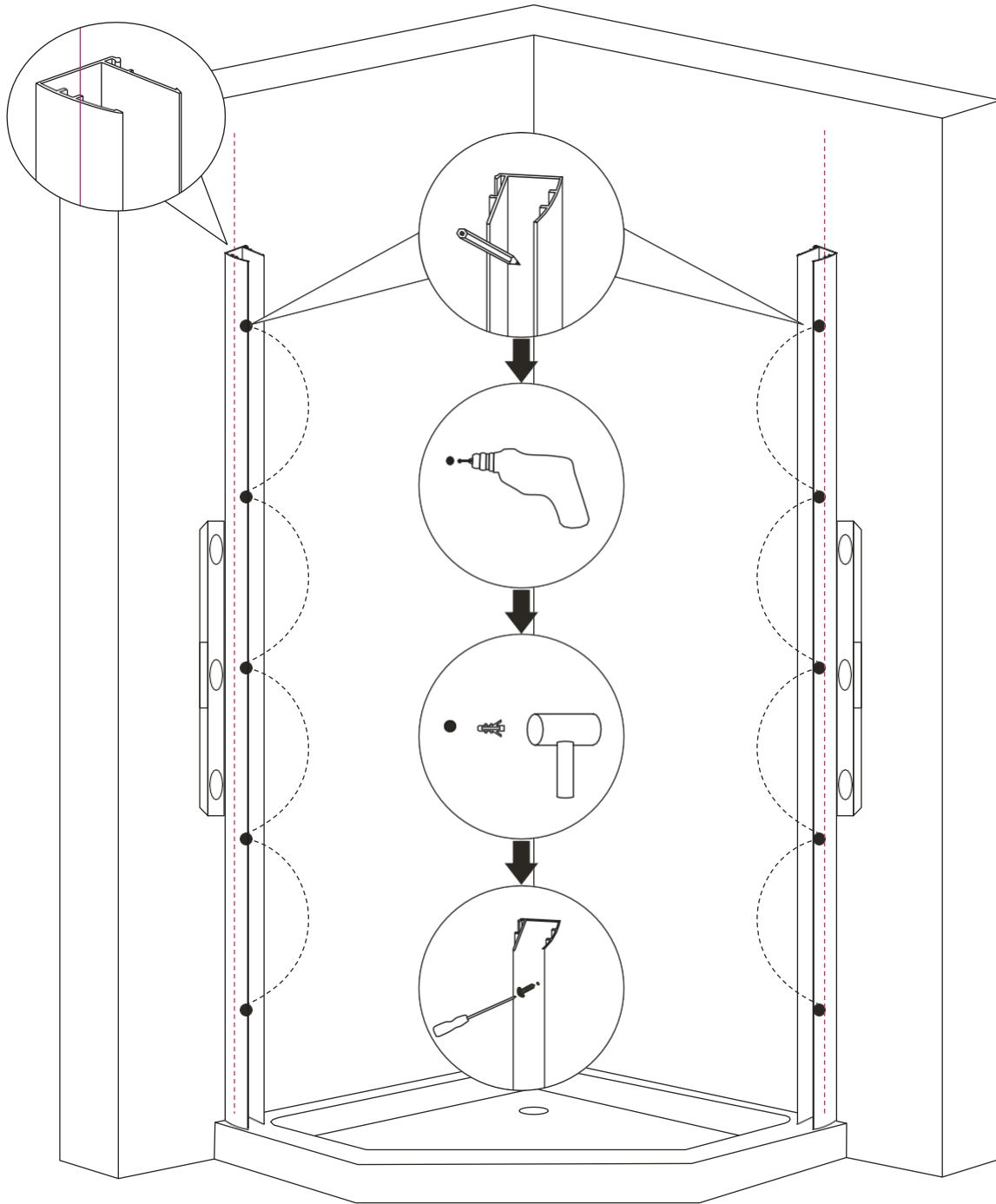
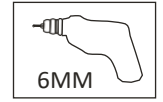
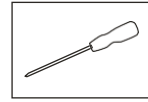
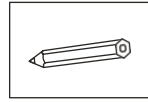
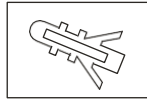
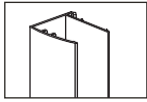
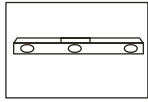
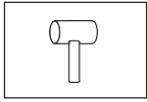
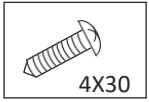

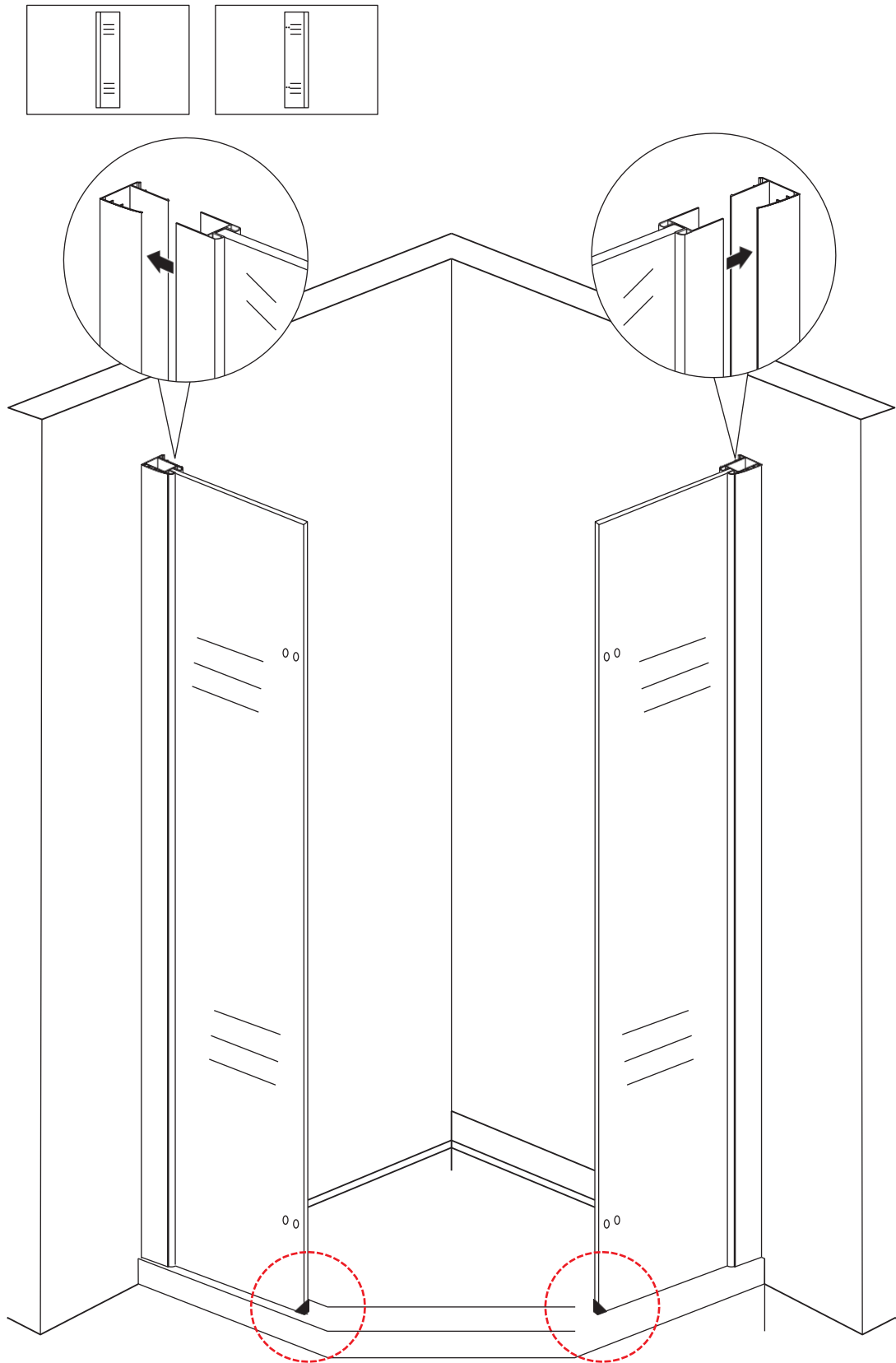

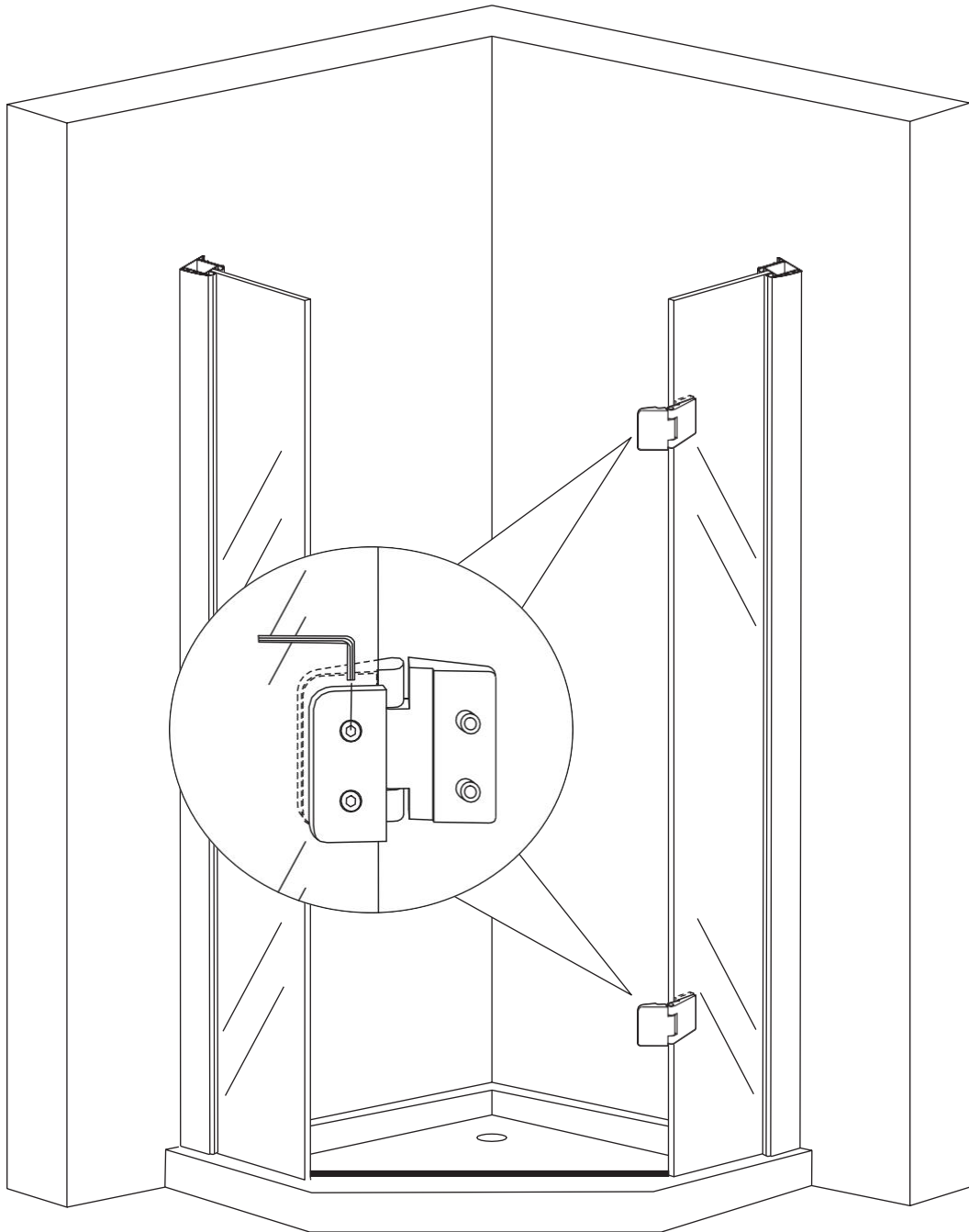
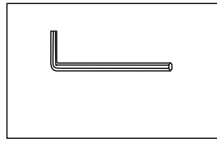
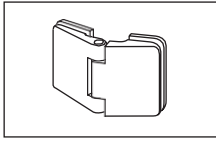

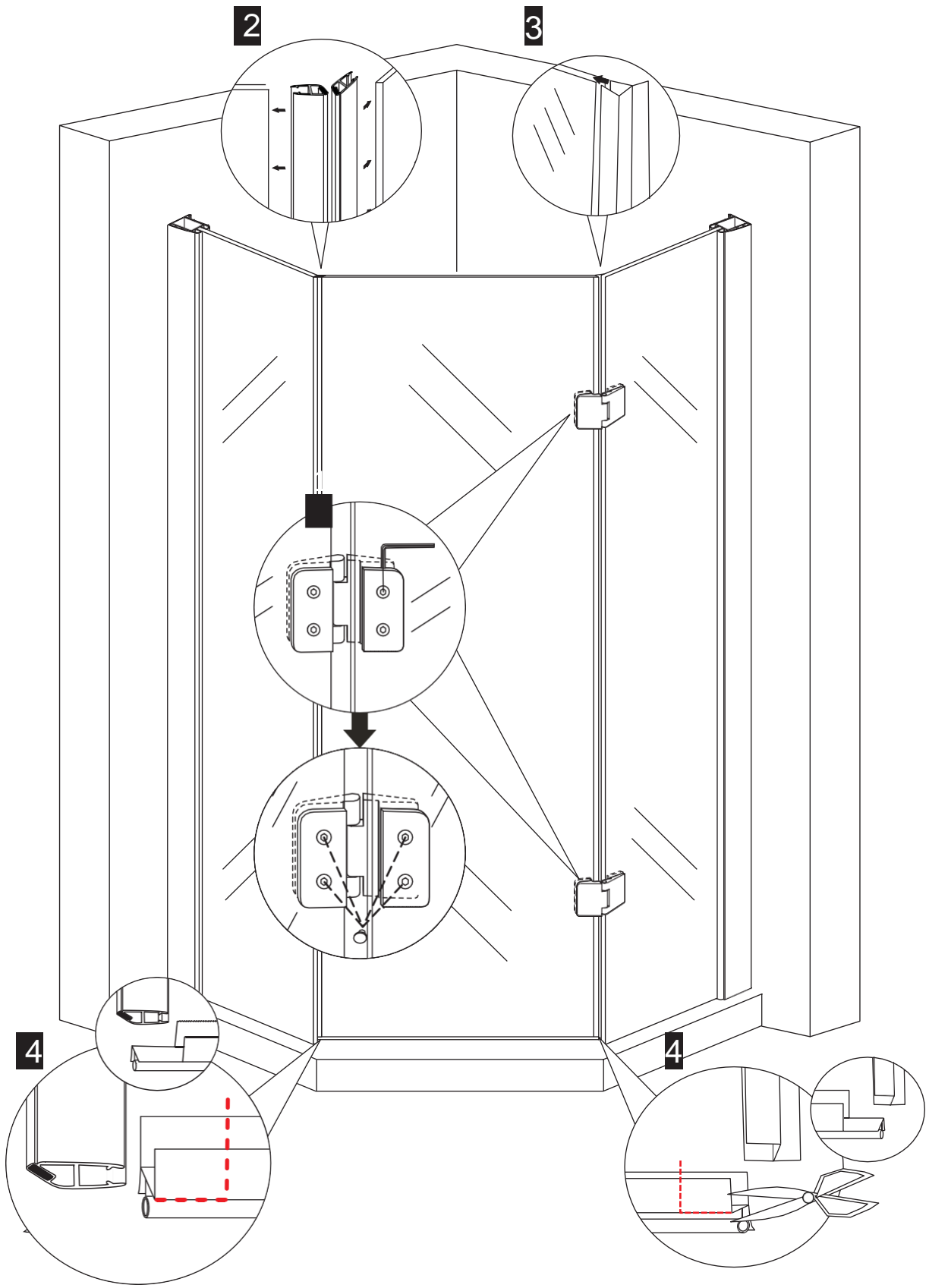
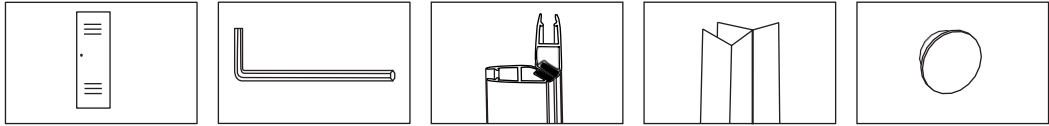

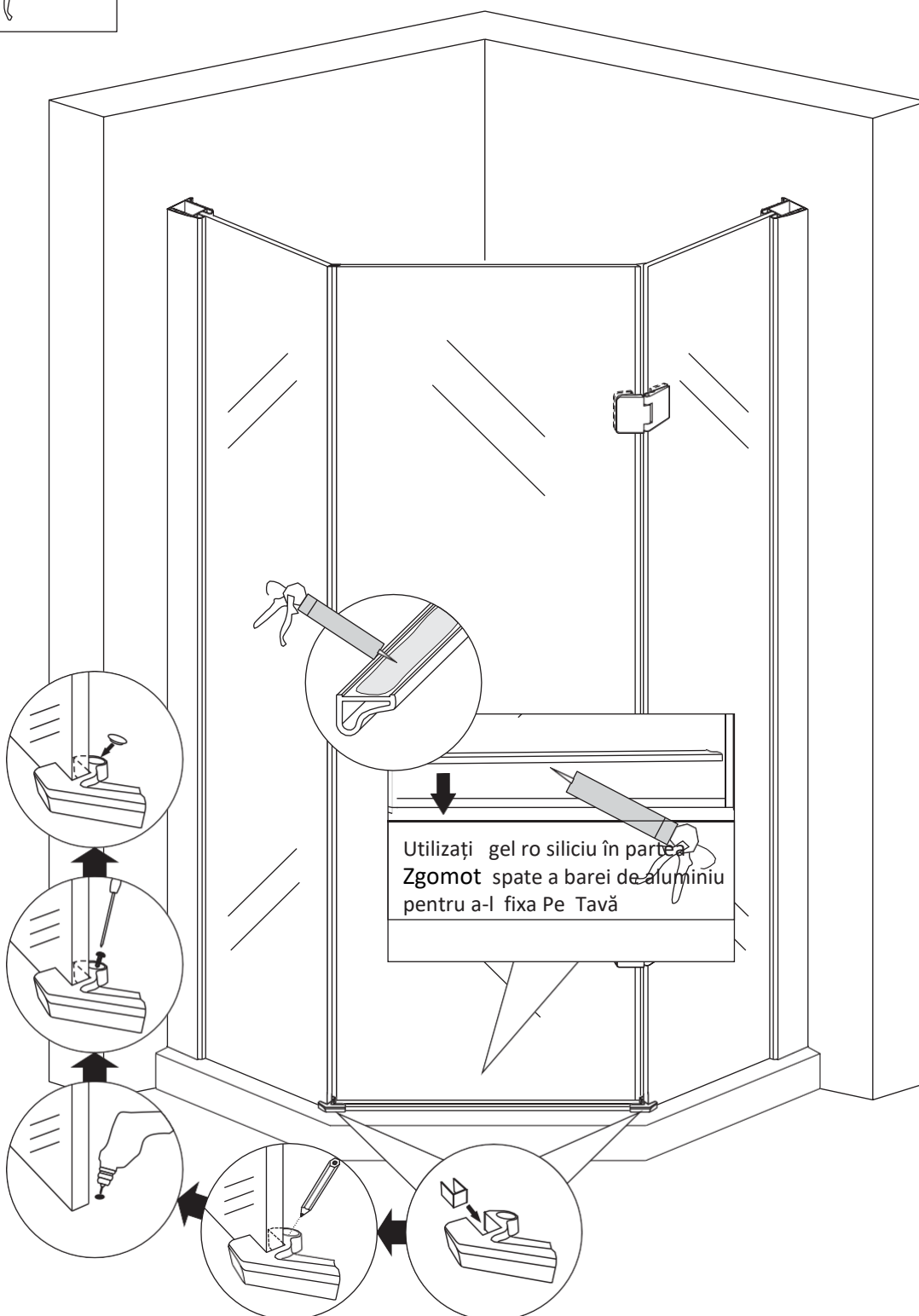
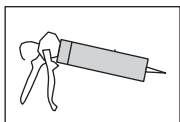
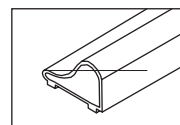
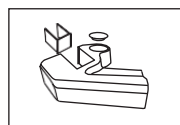
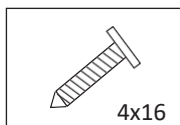
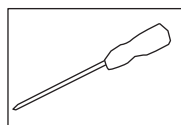
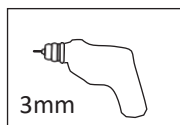
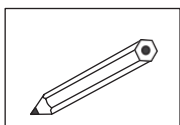

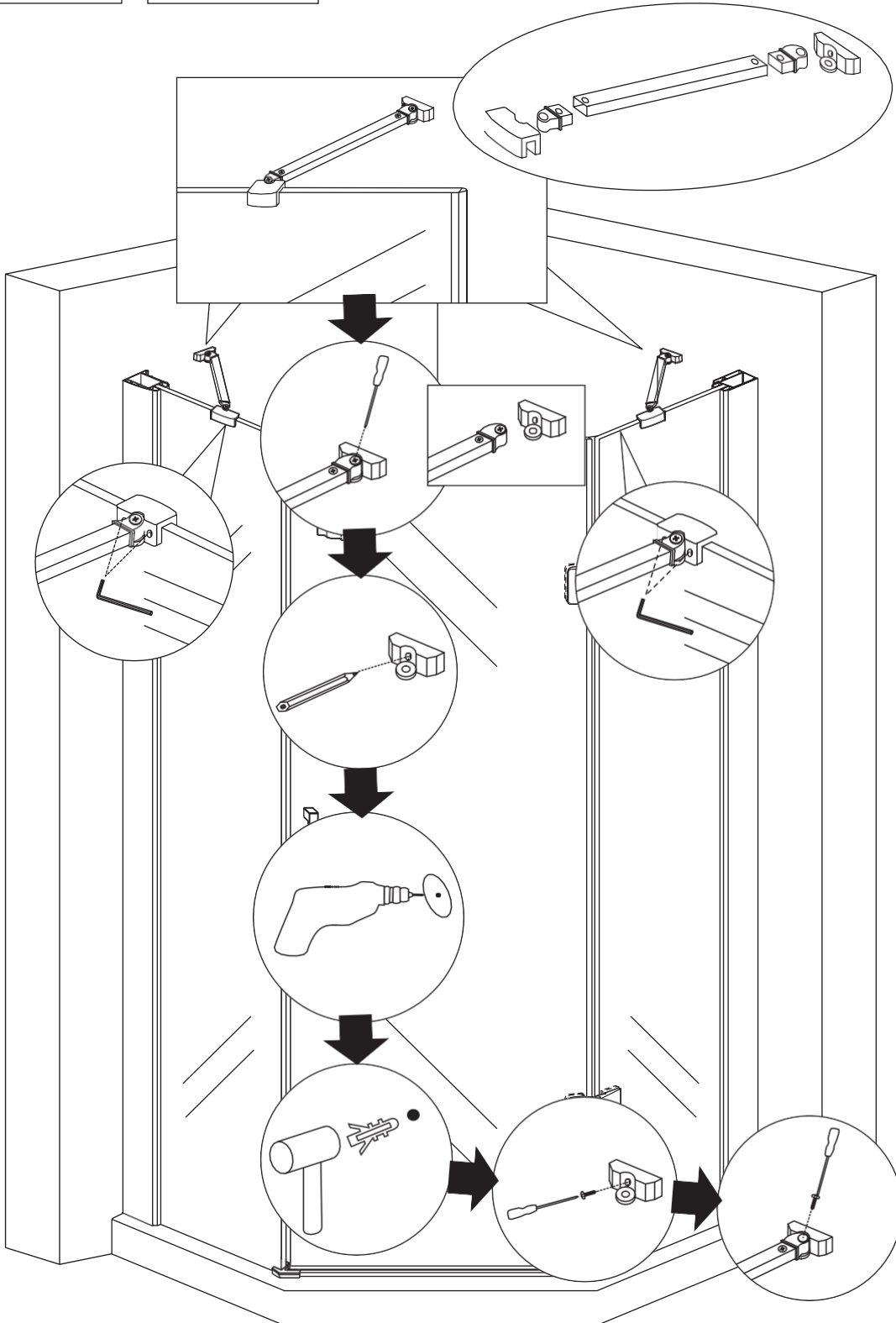
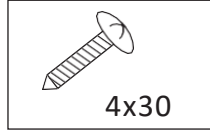
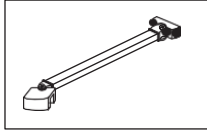
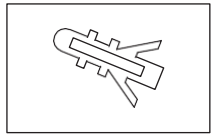
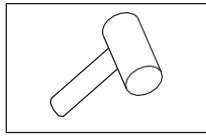
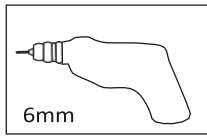
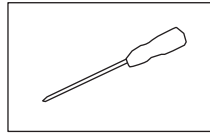
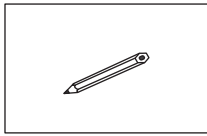

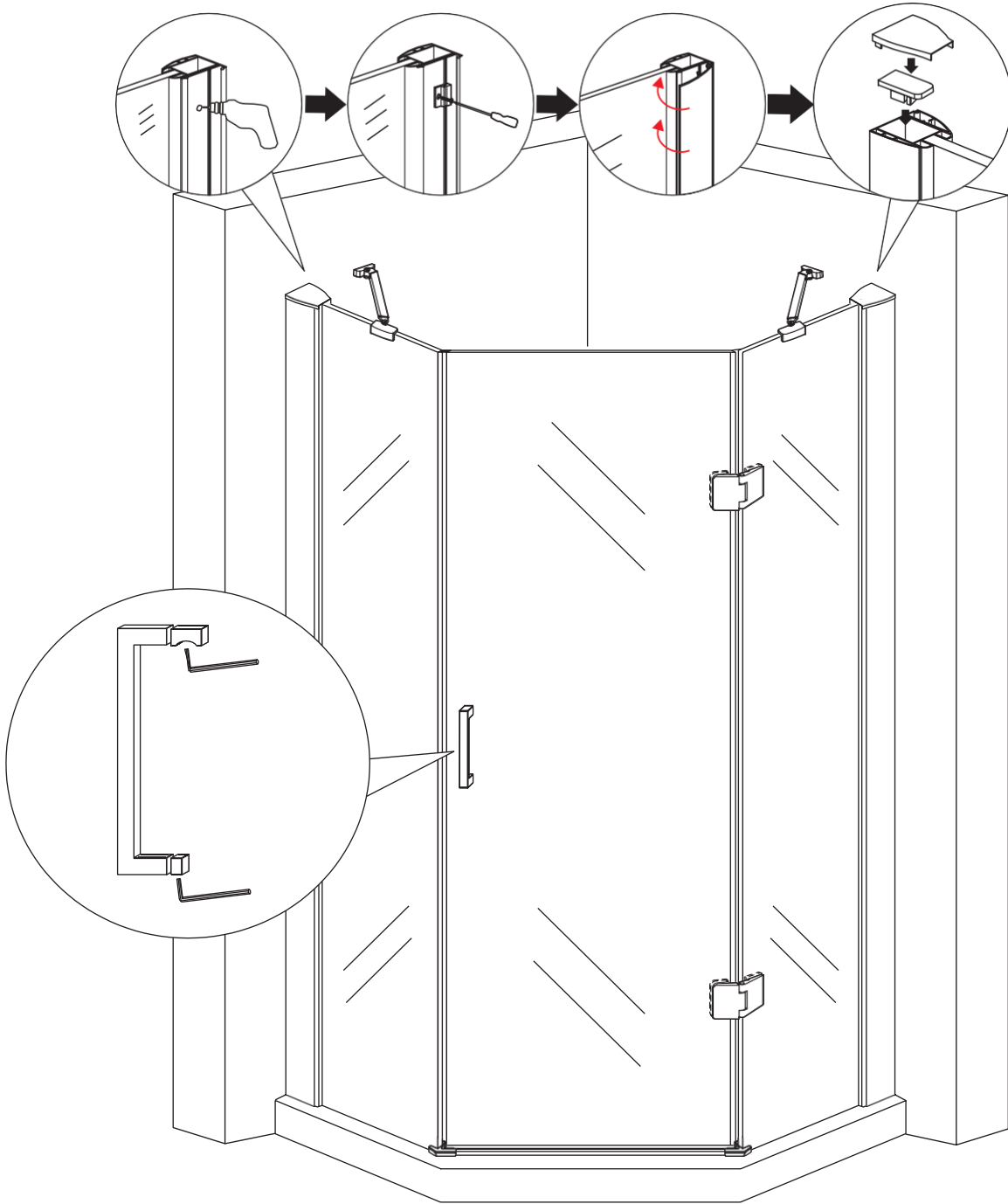
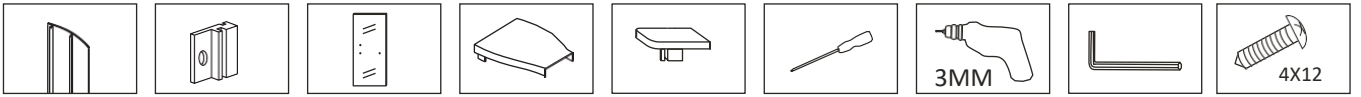

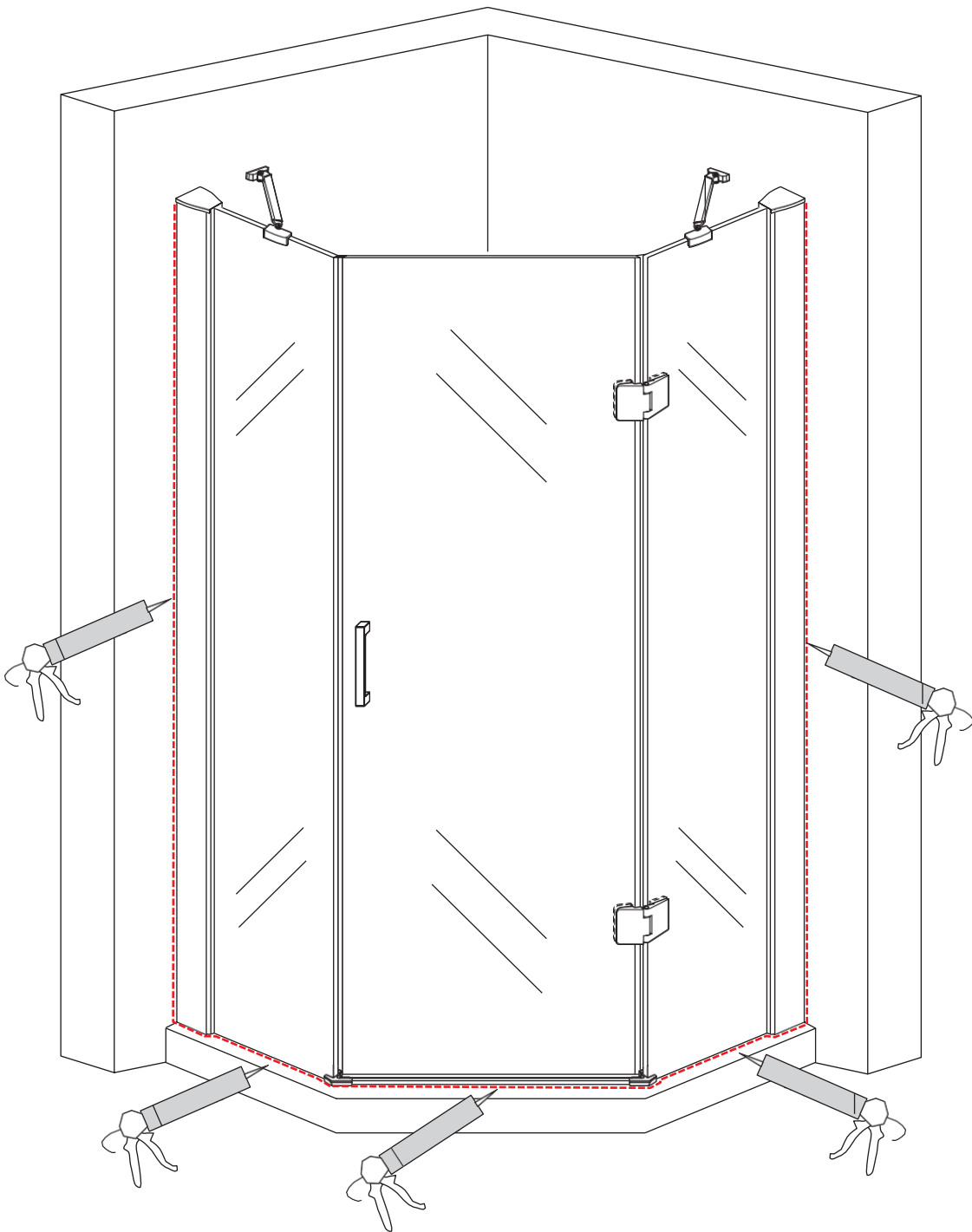
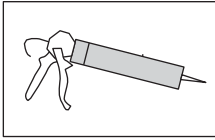

Leistungserklärung

nach Bauproduktverordnung (305/2011/EU)
Nr. 11 Sanitäreinrichtungen



1. Eindeutiger Kenncode des Produkttyps: 11 Sanitäreinrichtungen
2. Verwendungszweck (e): persönliche Hygiene
3. Hersteller: Glasdeals
Inh. Lars Apitius
Im Mühlenwert 20
58135 Hagen
Deutschland
4. Bevollmächtigter: /
5. System (e) zur Bewertung und Überprüfung der Leistungsbeständigkeit System 4
6. a) Harmonisierte Norm: EN 14428:2004 + A1:2008
Notifizierte Stelle (n): /
6. b) Europäisches Bewertungsdokument: /
Europäische Technische Bewertung: /
Technische Bewertungsstelle: /
Notifizierte Stelle (n): /
7. Erklärte Leistung (en): Reinigbarkeit - bestanden
keine scharfen Kanten, Grate und Ecken
Brucheigenschaften - bestanden
Dauerhaftigkeit - bestanden
8. Angemessene Technische Dokumentation /
und/oder Spezifische Technische
Dokumentation

Die Leistung des vorstehenden Produkts entspricht der erklärten Leistung/den erklärten Leistungen.
Für die Erstellung der Leistungserklärung im Einklang mit der Verordnung (EU) Nr. 305/2011
ist allein der obengenannte Hersteller verantwortlich.

Unterzeichnet für den Hersteller und im Namen des Herstellers von:

Name: Lars Apitius

Hagen, 16.01.17

Ort, Datum

Unterschrift **Glasdeals**
Inh. Lars Apitius
Im Mühlenwert 20
D-58135 Hagen