

Instrucțiuni de montaj

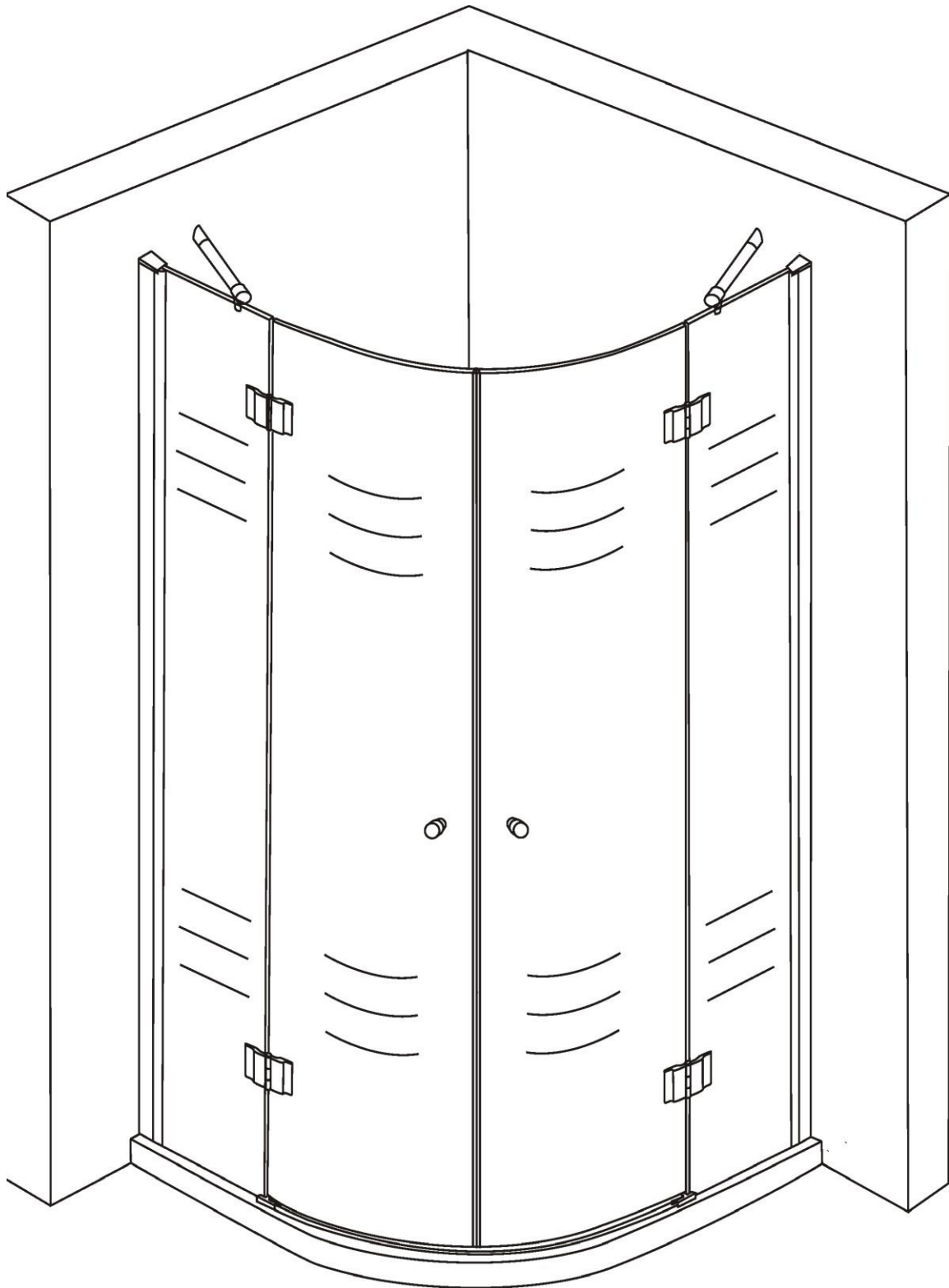

Instrument necesar

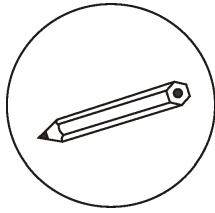

Creion

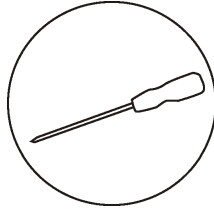

șurubelnița

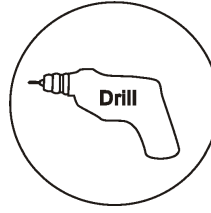

bormasina

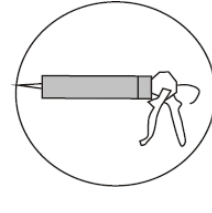

silicon

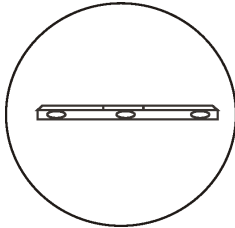

boloboc

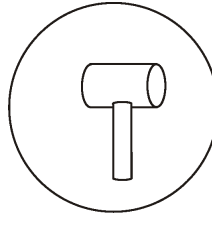

ciocan de cauciuc

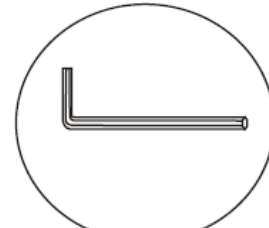

cheie hexagonală

Părți

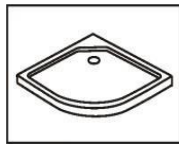

Tray

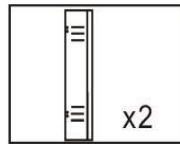

Glass

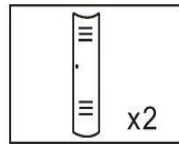

Glass

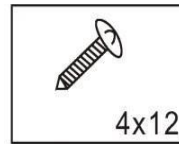

Screw

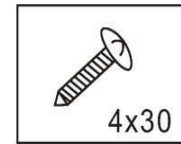

Screw

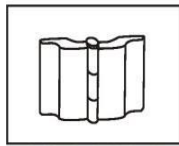

HY-3304

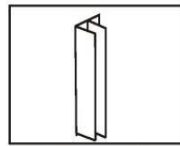

Wall profile

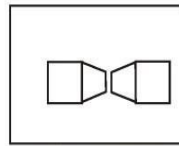

LS-1201

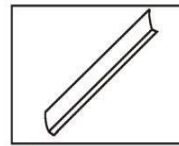

Side cover

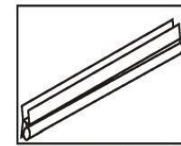

CT-8DSTQ

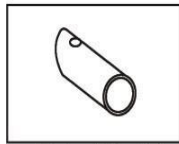

PJ-4317

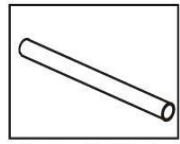

LG-2004

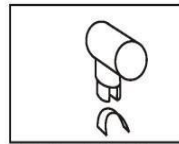

PJ-4416

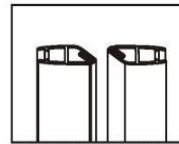

CT-8BMX90

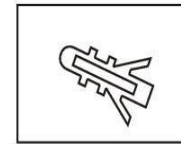

Expand tube



PJ-4526/
PJ-4527

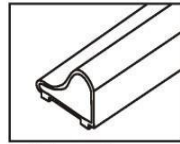

Aluminum
bottom bar

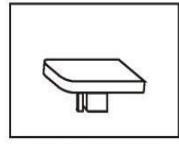

PJ-4509

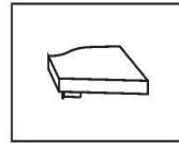

PJ-4514/
PJ-4515

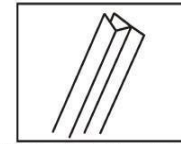

CT-8DST180

Marcați liniile de asamblare așa cum se vede în tabel

Măsurători	Profilul peretelui	L1	L2
800 x 800	Pre-foraj	765	765
900 x 900	Pre-foraj	865	865
1000 x 1000	Pre-foraj	965	965

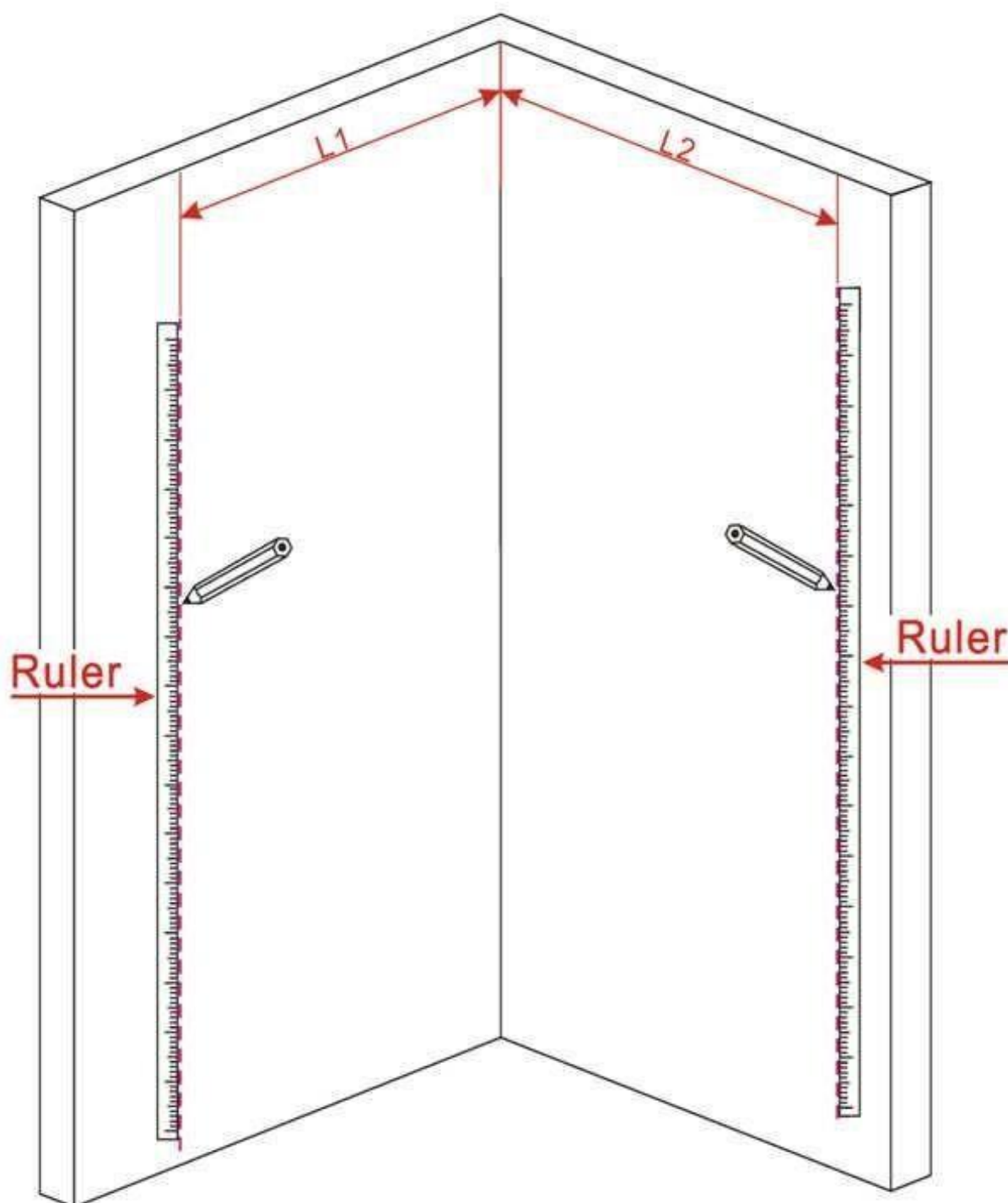

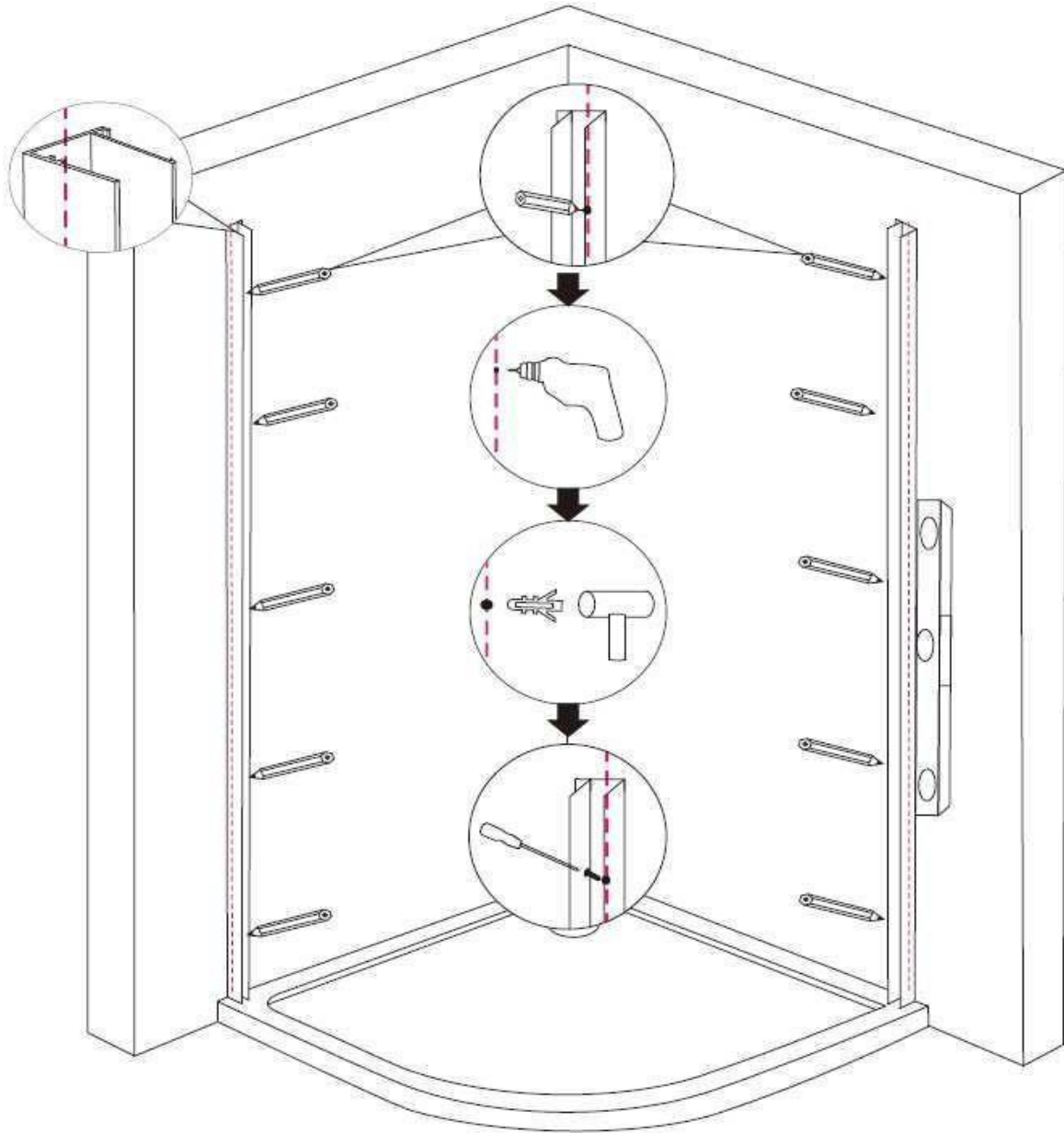

Introduceți cu atenție cele două elemente fixe în profilele de perete respective (lăsați protectorul de margine pe sticlă)

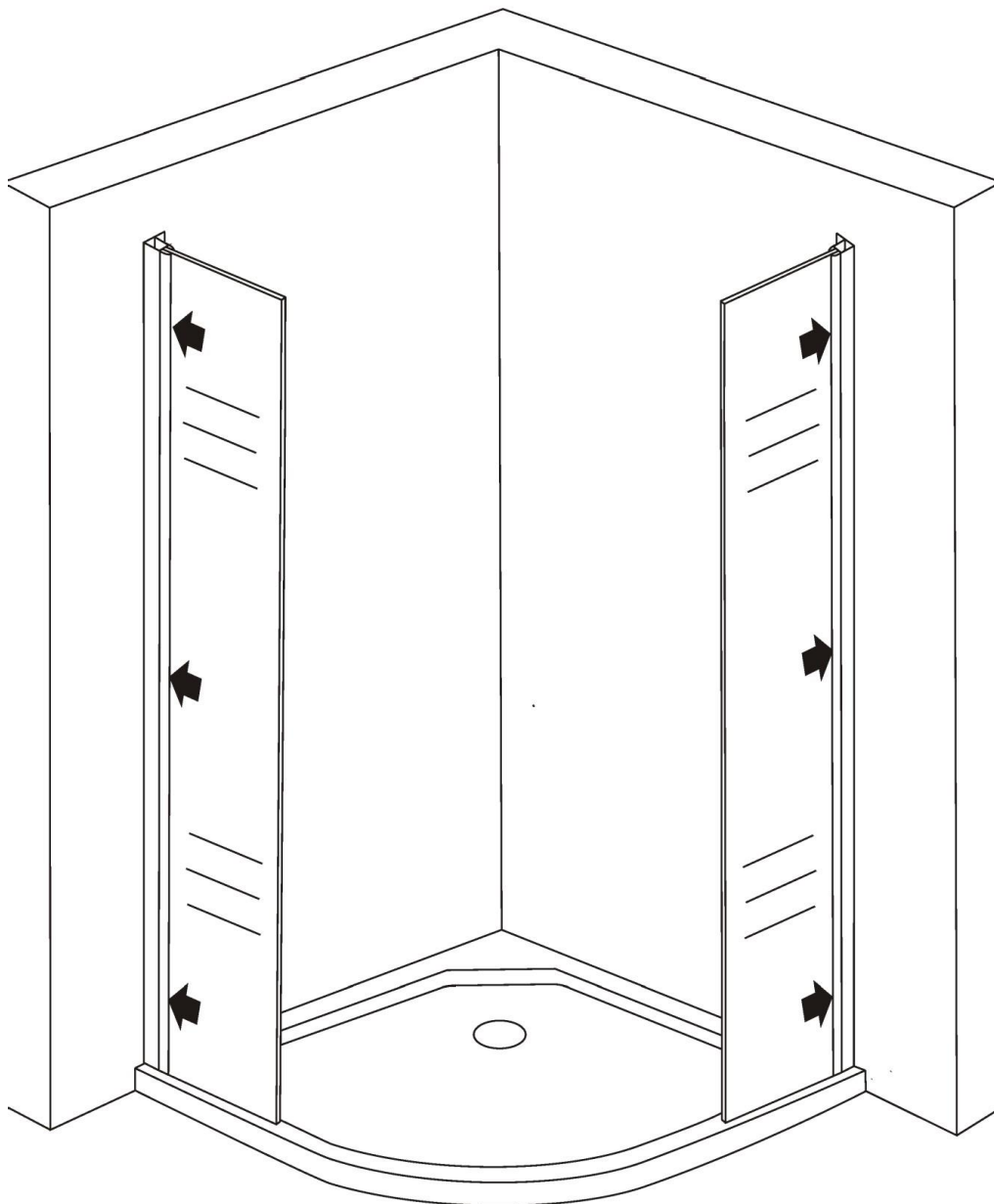
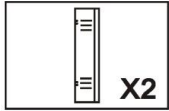

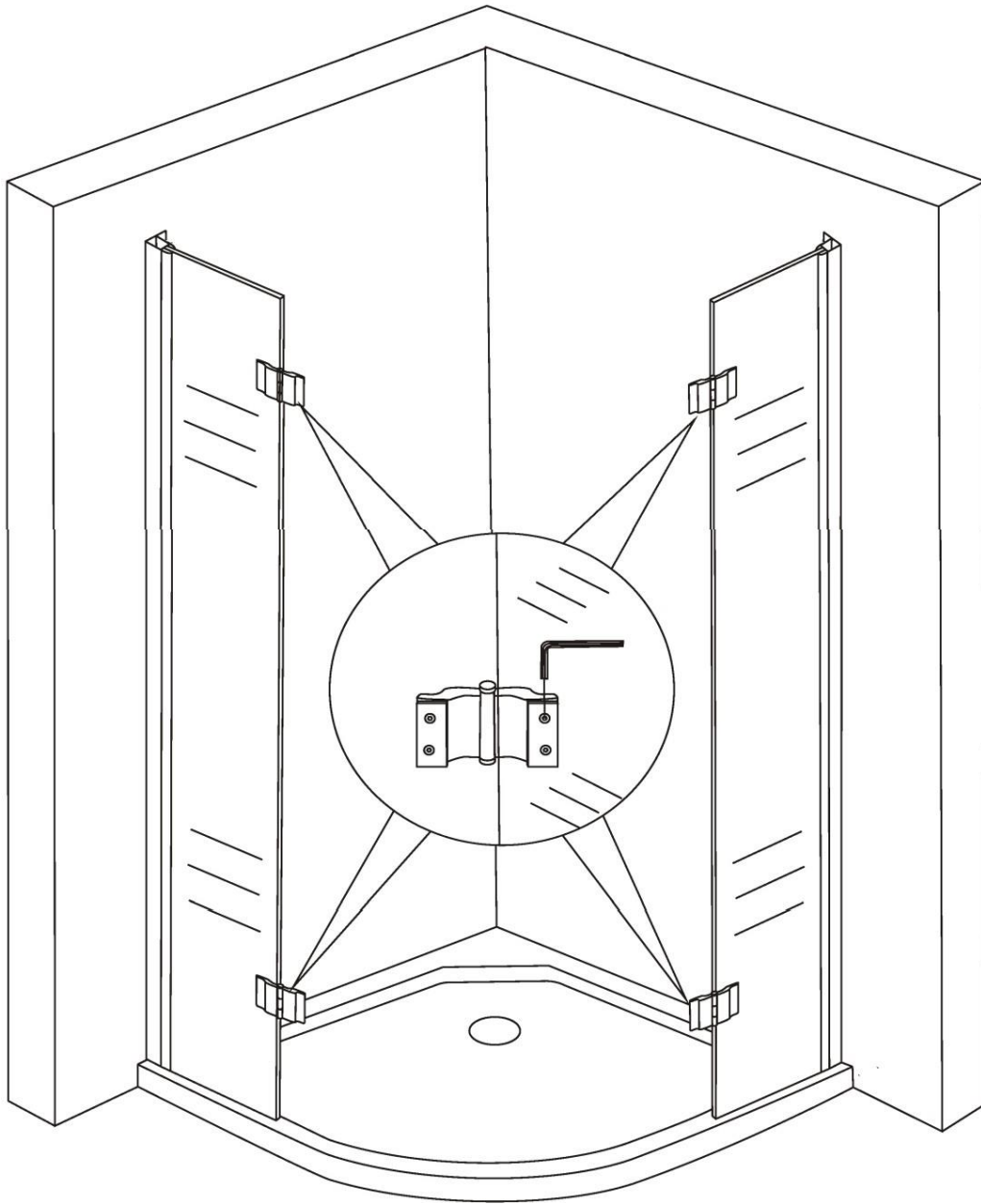
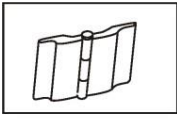

4

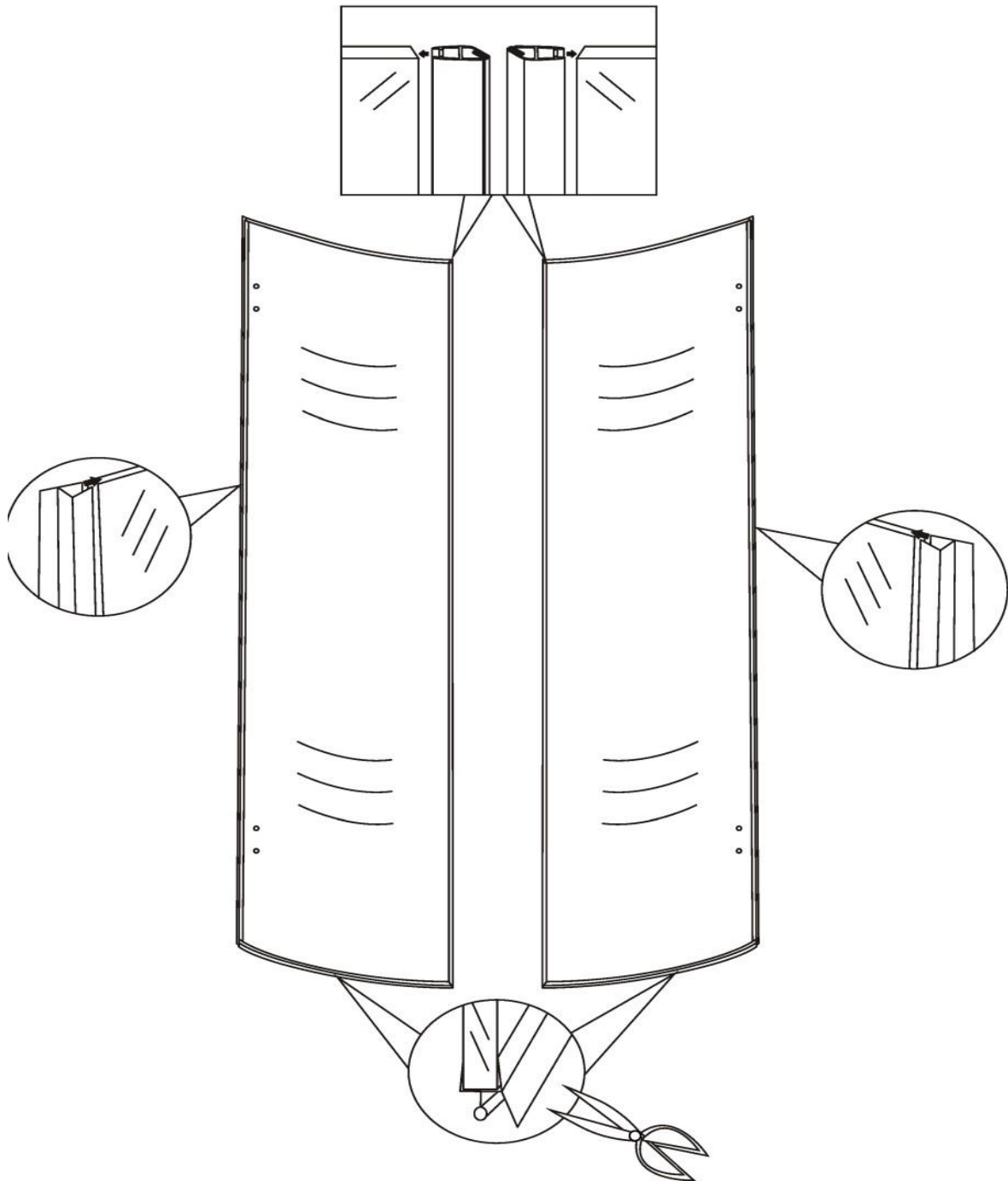
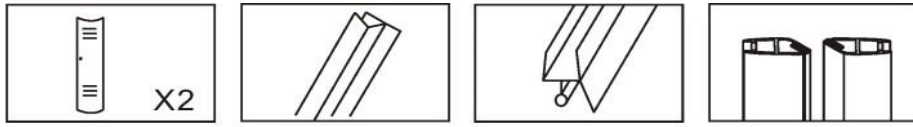

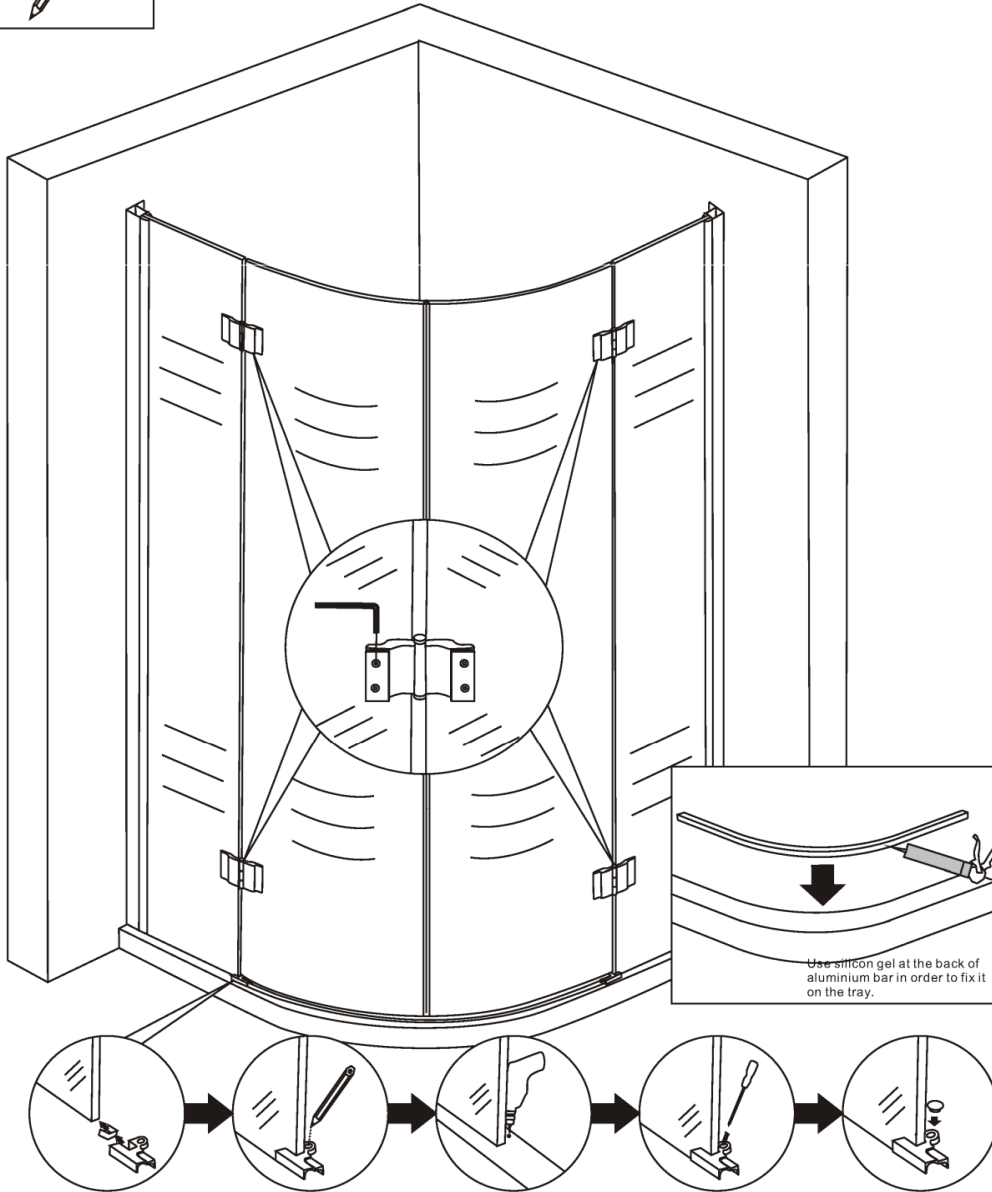
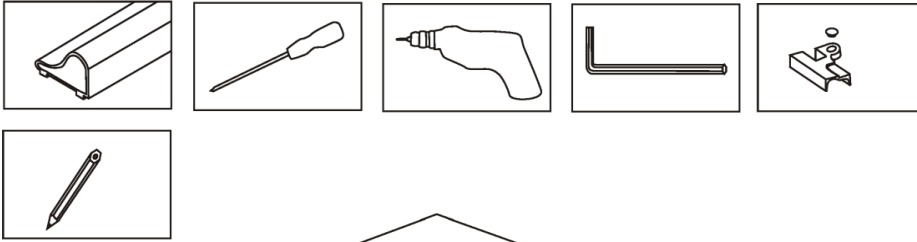

6

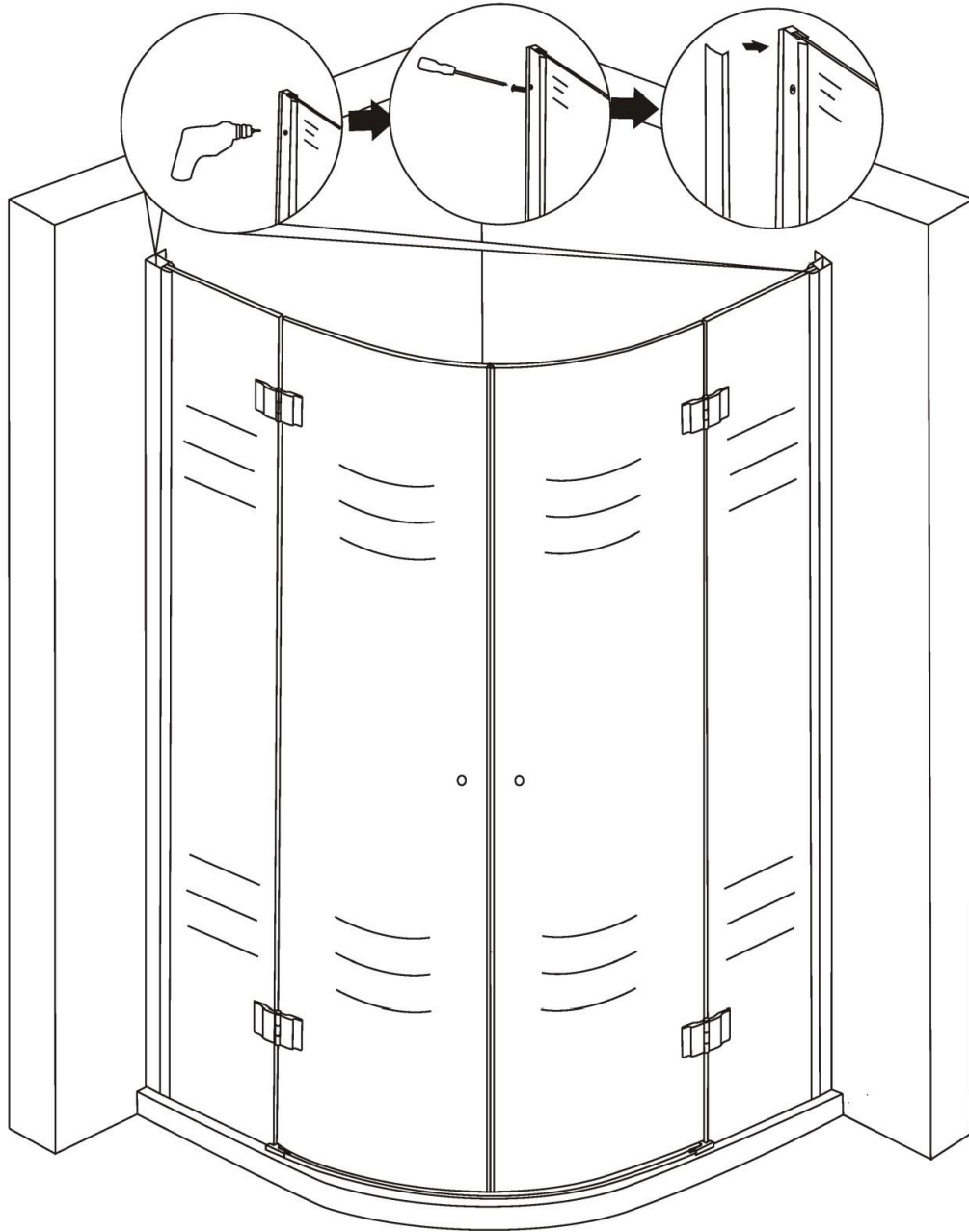
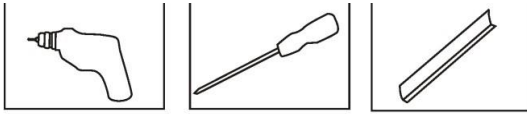

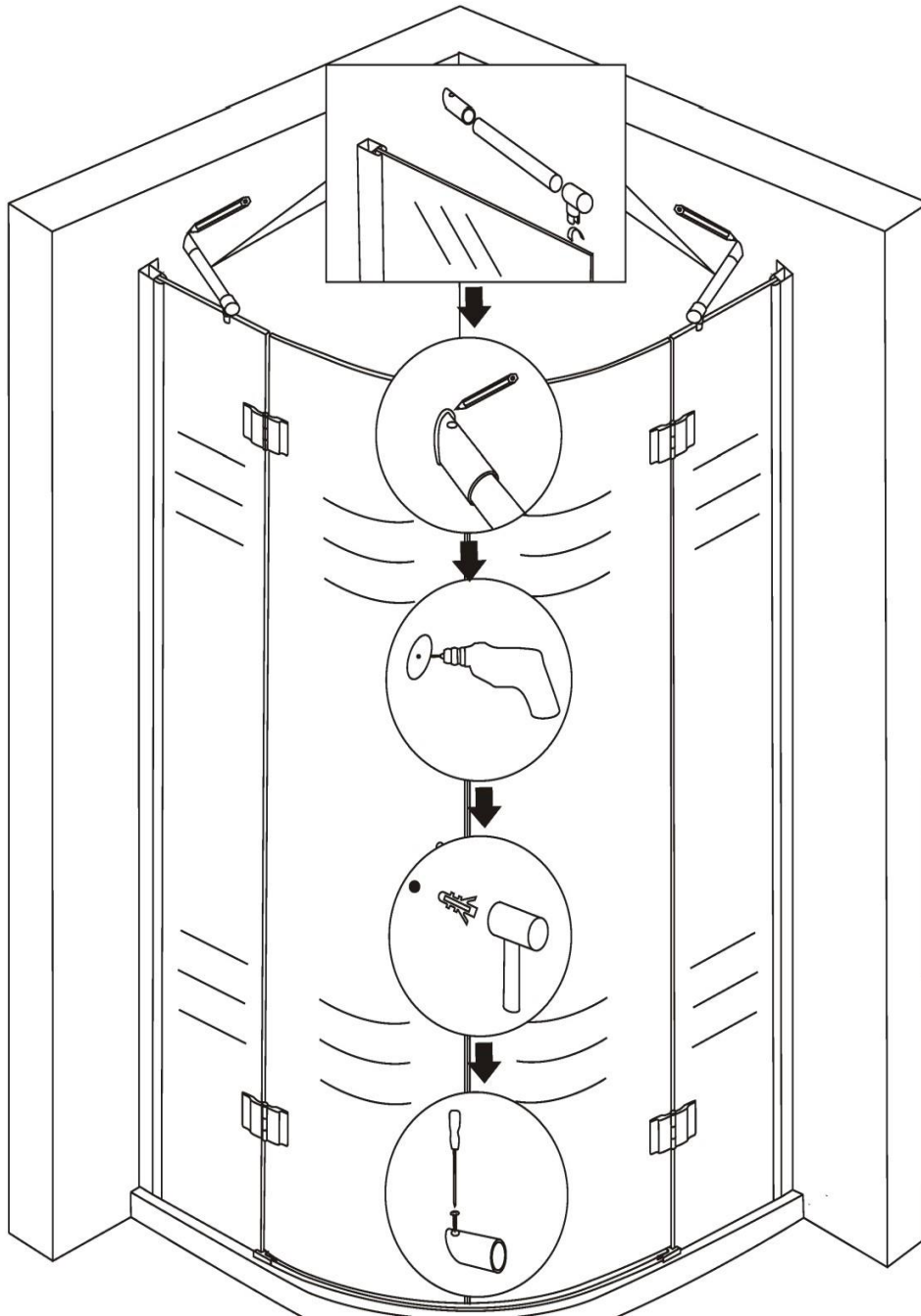
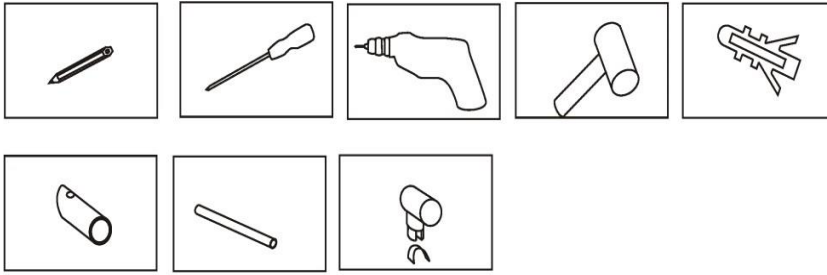

8

